

Review Article

Understanding specific functions of PARP-2: new lessons for cancer therapy

Syed O Ali¹, Farhaan A Khan¹, Miguel A Galindo-Campos², José Yélamos^{2,3}

¹School of Clinical Medicine, University of Cambridge, Cambridge, UK; ²Department of Immunology, Cancer Research Program, Institut Hospital del Mar d'Investigacions Mèdiques (IMIM), Barcelona, Spain; ³CIBERehd, Spain

Received August 27, 2016; Accepted August 31, 2016; Epub September 1, 2016; Published September 15, 2016

Abstract: Poly(ADP-ribose)ation (PARylation) is a widespread and highly conserved post-translational modification catalysed by a large family of enzymes called poly(ADP-ribose) polymerases (PARPs). PARylation plays an essential role in various cardinal processes of cellular physiology and recent approvals and breakthrough therapy designations for PARP inhibitors in cancer therapy have sparked great interest in pharmacological targeting of PARP proteins. Although, many PARP inhibitors have been developed, existing compounds display promiscuous inhibition across the PARP superfamily which could lead to unwanted off-target effects. Thus the prospect of isoform-selective inhibition is being increasingly explored and research is now focusing on understanding specific roles of PARP family members. PARP-2, alongside PARP-1 and PARP-3 are the only known DNA damage-dependent PARPs and play critical roles in the DNA damage response, DNA metabolism and chromatin architecture. However, growing evidence shows that PARP-2 plays specific and diverse regulatory roles in cellular physiology, ranging from genomic stability and epigenetics to proliferative signalling and inflammation. The emerging network of PARP-2 target proteins has uncovered wide-ranging functions of the molecule in many cellular processes commonly dysregulated in carcinogenesis. Here, we review novel PARP-2-specific functions in the hallmarks of cancer and consider the implications for the development of isoform-selective inhibitors in chemotherapy. By considering the roles of PARP-2 through the lens of tumorigenesis, we propose PARP-2-selective inhibition as a potentially multipronged attack on cancer physiology.

Keywords: Poly(ADP-ribose) polymerases, poly(ADP-ribose)ation, cancer, isoform-selective inhibition

Introduction

Poly(ADP-ribose) polymerase-2 (PARP-2) belongs to a family of seventeen ADP-ribosyltransferases, termed poly(ADP-ribose) polymerases (PARPs) [1]. While some PARPs are enzymatically inactive (PARP-9 and PARP-13) or catalyse only mono(ADP-ribose)ation of targets, PARP-2 alongside PARP-1, PARP-5A and PARP-5B are the only known PARPs which possess poly(ADP-ribose)ation activity (PARylation) [1]. PARylation involves the homopolymerisation of the ADP-ribose unit of β -NAD⁺ on specific target amino acids and the resulting poly(ADP-ribose) (PAR) polymers vary in size and branching, conferring diverse functional and structural effects on target proteins [1-3]. The modification itself is short-lived as the PAR polymer is rapidly degraded by poly(ADP-ribose) glycohydrolase (PARG) [4] and poly(ADP-ribose) hydrolase 3

(ARH3) [5]. PARP-2, together with PARP-1 and PARP-3 are activated by DNA strand breaks and are the only known DNA damage-dependent PARPs [6-8]. They target a plethora of proteins, largely involved in the DNA damage response, DNA metabolism and chromatin architecture but are also capable of automodification [1] (**Figure 1**). Recently, advances in proteomic screens have allowed identification of PARylation targets of PARP-1, PARP-2 and PARP-3, revealing new and specific functions of these modifications in cellular processes [20-22] including cell fate, genomic integrity, replication and metabolism [17, 23-26] and thus PARP inhibition may offer wide-ranging therapeutic utility (**Figure 1**).

PARP-1 and PARP-2 activity are intricately interwoven and double knockout *Parp-1^{-/-}Parp-2^{-/-}* mice exhibit early embryonic lethality [27].

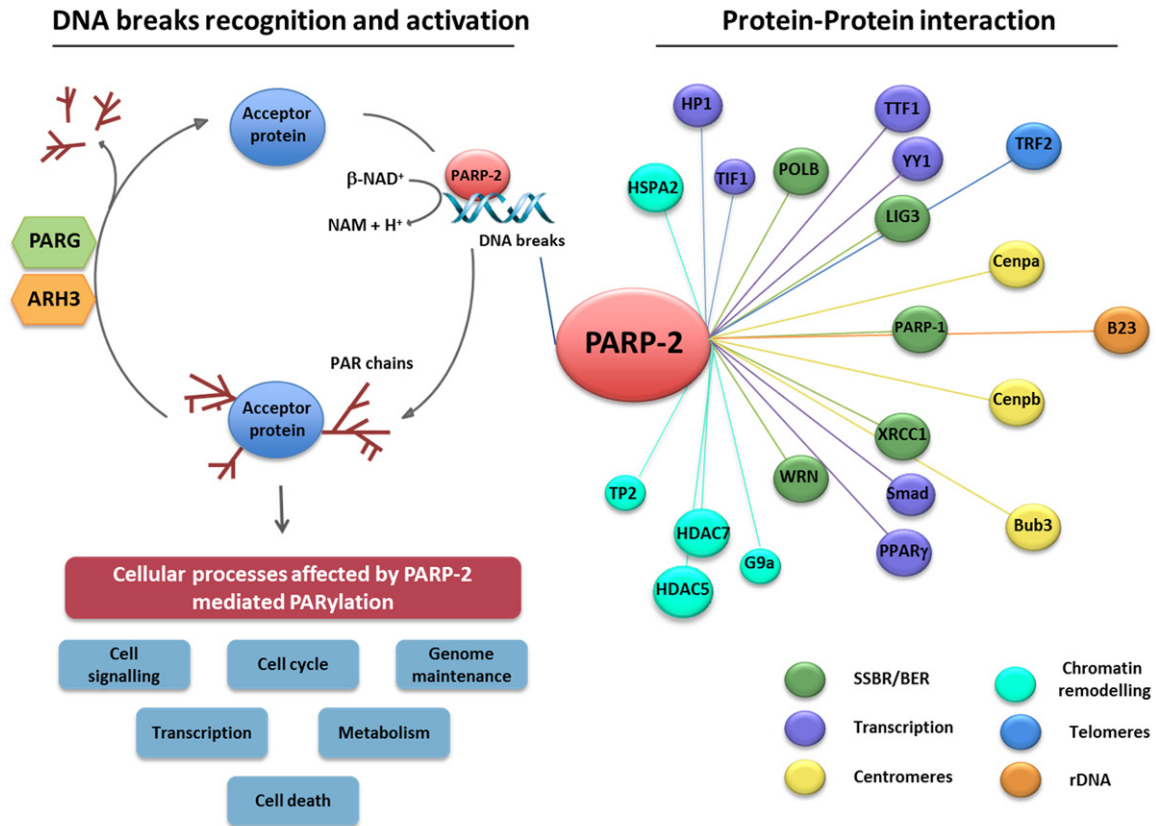

Figure 1. Poly(ADP-ribose) polymerase-2 (PARP-2) executes its biological functions via physical interaction with or PARylation of target proteins. PARP-2 is rapidly recruited to sites of DNA breakage leading to its enzymatic activation (left panel). Activated PARP-2, as well as other bona fide PARPs, hydrolyse NAD⁺ to nicotinamide (Nam) and one proton (H⁺), in doing so transferring an ADP-ribose moiety onto specific residues of protein substrates. The subsequent homopolymerisation of ADP-ribose molecules forms variable, long and branched chains of ADP-ribose polymer (PAR). Acceptor proteins subject to PARP-2-dependent PARylation are implicated in a wide range of biological processes, including genome maintenance, transcription, cell cycle regulation, cell death, cell signalling, and metabolism. The reverse reaction involves the rapid degradation of the PAR polymer by poly(ADP-ribose) glycohydrolase (PARG) and poly(ADP-ribose) hydrolase-3 (ARH3) which hydrolyse poly(ADP-ribose) into ADP-ribose units. Biochemical approaches and proteomics show that PARP-2 also physically associates with various protein partners (right panel) involved in different biological processes [9-19].

Although at present, PARP inhibitors display promiscuous inhibition among the PARP superfamily [28, 29], it is becoming increasingly clear that PARP-2 regulates an overlapping but distinct target set to that of PARP-1 [20-22, 30]. New PARP-2 specific roles are being uncovered in diverse functions ranging from DNA repair [17] to telomeric integrity [15] and PARP-2, through physical interaction with or PARylation of partner proteins, impinges on various cellular processes dysregulated in tumorigenesis (Figure 1). Here, we review emerging roles of PARP-2 in many of the hallmarks of cancer and how this may impact the design and therapeutic potential of PARP-2-selective inhibitors in cancer treatment.

Parp-2 gene and protein organization

The *Parp-2* gene, mapping to position 14q11.2 and 14C1 [6, 31] in the human and murine genome respectively, consists of a sequence of around 13 kb comprising 16 exons and 15 introns (Figure 2A). Eleven transcripts, generated by alternative splicing, have been described (www.ensembl.org), of which some encode PARP-2 protein isoforms (Figure 2B). However, the biological significance of these protein variants is largely unknown. The 62 kDa PARP-2 protein is composed of a modular structure, conserved across the DNA damage-dependent PARPs, comprising an N-terminal region (NTR), a central WGR (Trp-Gly-Arg) domain and

PARP-2 and cancer

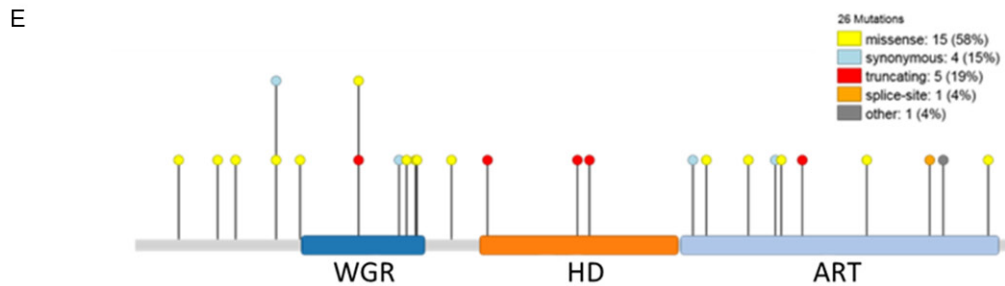
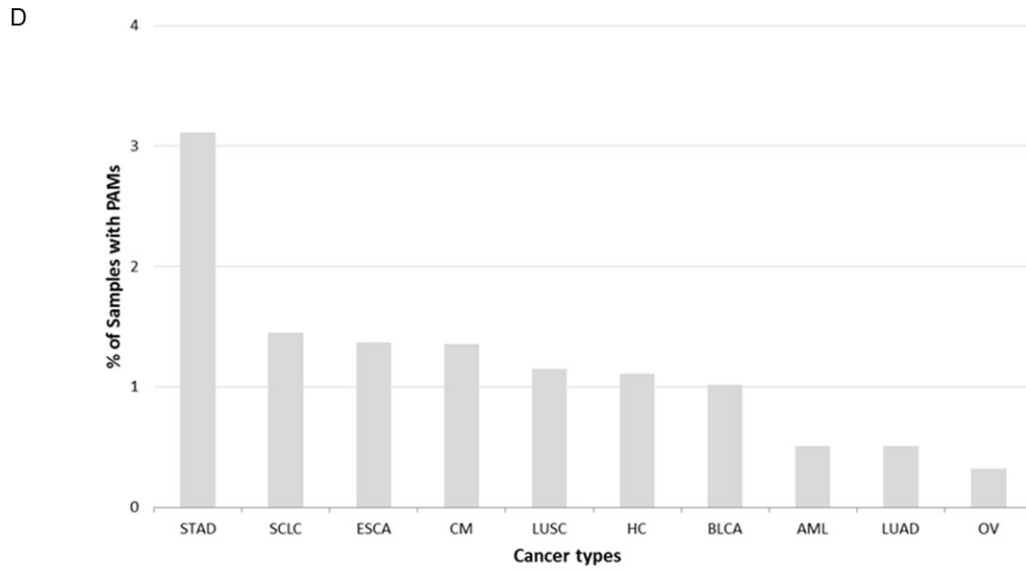
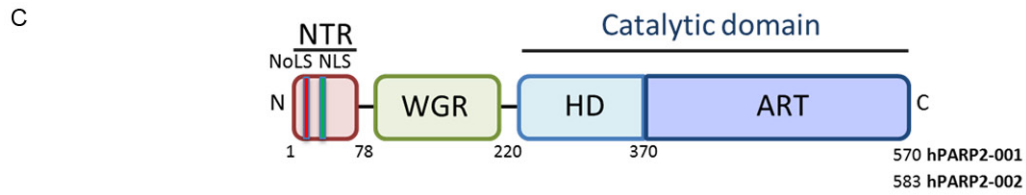
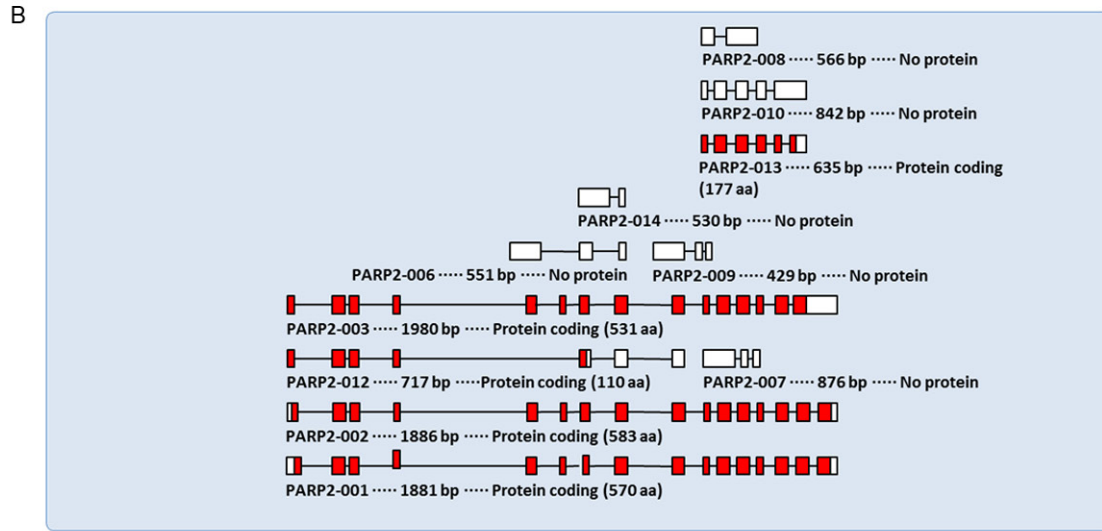
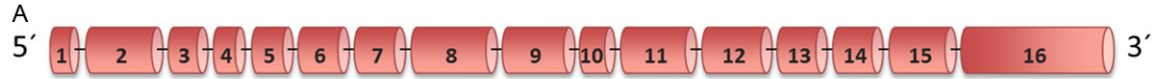

Figure 2. Gene and protein organization of PARP-2. (A) Schematic representation of the genomic DNA organization of the human PARP-2 gene showing exons numbered 1-16 (B) Schematic representation of the transcript variants of PARP-2 (www.ensembl.org). (C) Schematic representation of the domain structure of the human PARP-2 protein. NTR, N-terminal region; WGR, Trp-Gly-Arg domain; HD, helical domain; ART, ADP-ribosyltransferase domain; NoLS, Nucleolar localization signal; NLS, Nuclear localization signal. (D) Graph showing the frequency of PARP-2 mutations in different cancers (www.intogen.org). PAMs, Protein affecting mutations; STAD, stomach adenocarcinoma; SCLC, small cell lung carcinoma; ESCA, esophageal carcinoma; CM, cutaneous melanoma; LUSC, lung squamous cell carcinoma; HC, hepatocarcinoma; BLCA, bladder carcinoma; AML, acute myeloid leukemia; LUAD, lung adenocarcinoma; OV, serous ovarian adenocarcinoma. (E) Distribution of mutations along the PARP-2 protein identified in different types of tumour (www.intogen.org).

a C-terminal catalytic (CAT) domain composed of a helical subdomain (HD) and the ADP-ribosyltransferase (ART) subdomain, which allow coupling of catalysis to DNA break detection [32] (**Figure 2C**). The PARP-2 NTR is natively unstructured [32] and bears homology with the SAP domain of other nuclear proteins involved in DNA repair and chromosomal structure such as Ku70 and APE-1 [7, 32]. Residues 1-65 contain a highly basic DNA-binding domain (DBD) with lysine or arginine residues constituting 27% of its sequence [6], a bipartite nuclear localisation signal (NLS) and a nucleolar localisation signal (NoLS) [3, 19]. In contrast, the PARP-1 DBD contains three zinc finger DNA-binding motifs and a BRCA C-terminus (BRCT) domain [33]. These architectural differences between the PARP-1 and the PARP-2 DBDs translate into disparate DNA structure recognition. Although PARP-1 and PARP-2 exhibit similar binding affinity for nicked DNA, PARP-1, unlike PARP-2, also binds strongly to double-strand breaks (DSBs) and to a lesser extent, undamaged DNA, revealing greater specificity of PARP-2 for single-strand break (SSB) recognition [34]. Post-translational modifications on the NLS by the nuclear histone acetyltransferases P/CAF and GCN5L acetylating K36 and K37 serve to decrease DNA binding and enzymatic activity *in vitro* by an unknown mechanism [35]. Recent mutational analysis has shown that the PARP-2 NTR is, unexpectedly, not required for DNA-binding but is critical for PARP-2 activation on SSBs. Indeed, the WGR and CAT domain display cooperative binding to DNA damage substrates [32]. Interdomain contacts between the WGR and CAT domains appear to be particularly important for this interaction, with mutational disruption thereof reducing DNA-binding activity and abrogating PARP-2 DNA-dependent allosteric activation [32]. Furthermore, while the NTR confers nuclear and nucleolar localisation, it is not necessary for recruitment of PARP-2 to sites of DNA

damage, a function mediated instead by a combination of the WGR and CAT domains [32].

The PARP-2 WGR domain is homologous in structure to that of PARP-1 but mediates homodimerisation, DNA damage-dependent autoPARylation and protein-protein interactions-functions attributed to the BRCT motif-bearing domain D of PARP-1 [17]. The WGR domain of PARP-2 is interposed between a caspase-3 cleavage site^{58-DNRD}⁶¹, and a caspase-8 cleavage site^{183-LQMD}¹⁸⁶ just proximal to the border with the C-terminal catalytic domain. The effect of caspase-8 cleavage is to inactivate PARP-2 but both PARP-1 and PARP-2 are also cleaved by caspase-3, which may enhance DNA damage and allow for swift chromatin degradation in apoptosis by inhibition of PARylation [36]. Moreover, apoptosis is ATP-dependent [37] and PARP inactivation prevents ATP depletion from NAD⁺ salvage reactions, thus also ensuring the seamless execution of cell suicide [36].

The C-terminal catalytic domain of PARP-2 bears 69% homology with PARP-1 [38] and operates by a similar mechanism of PARylation. Some structural differences, which may be of importance to the design of isoform-selective inhibitors, are evident from structural comparisons of the catalytic domains of human PARP-1 and PARP-2 in complex with the PARP-1/2 inhibitor BMN 673 [39]. Crystallographic analysis of these PARP-inhibitor complexes reveal similar modes of binding of BMN 673 to the PARP-1 and PARP-2 nicotinamide-binding pocket, mediated by a conserved network of hydrogen bonding and π -stacking forces [39]. In contrast, residues at the periphery of the NAD⁺ recognition site exhibit least conservation between the catalytic domains. Unique interactions between the PARP active site N-terminal helical bundle and D-loop with the di-branched scaffold of the inhibitor suggest new targets for the design of PARP-2-selective inhibitors [39].

PARP-2 and cancer

Table 1. PARP-2 polymorphisms in human cancer

Reference cluster ID (rs#)	Chr Pos*	Nucleotide change	Consequence	Amino acid change	Cancer association	Ref.
rs200603922	14:20811843	c.43A>G	Missense	R15G	Prostate†	[40]
rs3093926	14:20354893	c.848G>A	Missense	R283Q	Prostate Ovarian (<i>BRCA2</i> mutation carriers)	[41] [42]
rs878157	14:20356854	c.1329+165C>T	Intron variant	-	Breast	[43]
rs1713413	14:19891955	c.601-129C>G	Intron variant	-	Bladder	[44]
rs3093938	14:20356935	c.1330-116A>G	Intron variant	-	Colorectal adenoma	[45]
rs878156	14:20356700	c.1329+11T>C	Intron variant	-	Breast‡	[46]

*Chromosome position. †Partial segregation with prostate cancer in 5 individuals lacking mutations in *BRCA1/2*. ‡Carriers of rs878156 with breast cancer exhibit differential prognosis dependent on type of chemotherapy with improved survival with anthracycline-based chemotherapy.

New evidence is emerging revealing PARP-2 polymorphisms and mutations (www.intogen.org) associated with different cancers (**Figure 2D** and **2E**), suggesting a role of PARP-2 in tumorigenesis (**Table 1**).

PARP-2 and the hallmarks of cancer

Carcinogenesis is a multistage process which involves the stepwise accumulation of various mutations, some of which confer tumour cells a survival advantage. Many of the resulting phenotypes acquired are shared between different tumours and are considered ‘hallmarks of cancer’ (**Figure 3**) [47]. Among these hallmarks are genomic instability, sustained growth signalling, dysregulated cellular metabolism, angiogenesis, inflammation, tumour invasion and immune evasion [47]. As we continue to uncover specific biological functions of PARP-2, it is becoming increasingly clear that PARP-2 is variously involved in many of these hallmarks of cancer (**Figure 3**), thus raising the possibility of targeting specific PARP-isoforms in cancer therapy.

Role of PARP-2 in maintaining genomic stability

The genome is vulnerable to a multitude of genotoxic insults, both exogenous (ionising radiation, mutagenic chemicals) and endogenous (reactive oxygen species, recombination intermediates, replicative errors). Thus, mechanisms exist in cells, globally termed the DNA damage response (DDR), to detect damage, signal its presence to effectors and repair the lesion, coordinated with apoptotic or cell cycle arrest responses. Defects in these processes result in genomic instability, which is a major factor in tumorigenesis [48]. High-fidelity repli-

cation, intact DNA repair pathways, accurate chromosome segregation in cell division and proper coupling of these processes to cell cycle progression are the major factors driving genome surveillance and maintenance [48]. Genome instability is thus found to arise from various factors including replication stress, aberrant DNA repair, disruption of chromatin architecture, chromosome segregation defects, cell cycle dysregulation and telomere dysfunction [49]. New data are increasingly revealing specific functions of PARP-2 in these biological processes, information critical to the rational development and use of PARP-2-specific inhibitors.

The first indication of PARP-2 involvement in genomic stability came from the observation that *Parp-2*^{-/-} mice are highly sensitive to ionising radiation (IR) and alkylating agents, although to a different extent to PARP-1 deficiency, with PARP-2 but not PARP-1 deficiency also producing hyperradiosensitivity to low-dose IR (<2 Gy) [50]. *Parp-2*^{-/-} murine bone marrow cells irradiated with 2 Gy IR exhibit increase chromosome breakage, particularly in centromeres and treatment with the alkylating agent, N-methyl-N-nitrosourea (MNU), results in increased sister chromatid exchange events [27]. While PARP-2 deficiency is not alone tumorigenic, if combined with loss of p53 (**Table 2**), the rate of spontaneous tumour formation is accelerated [51] and this coupled with the aforementioned sensitivities to genotoxicity and known DNA-damage induced DNA-binding of PARP-2 [6], point towards a role of the molecule in the DDR. Mouse models deficient in both PARP-2 and other DDR proteins (**Table 2**) are increasingly revealing specific functional interactions of PARP-2, information both critical to understanding its role in the maintenance of genomic

PARP-2 and cancer

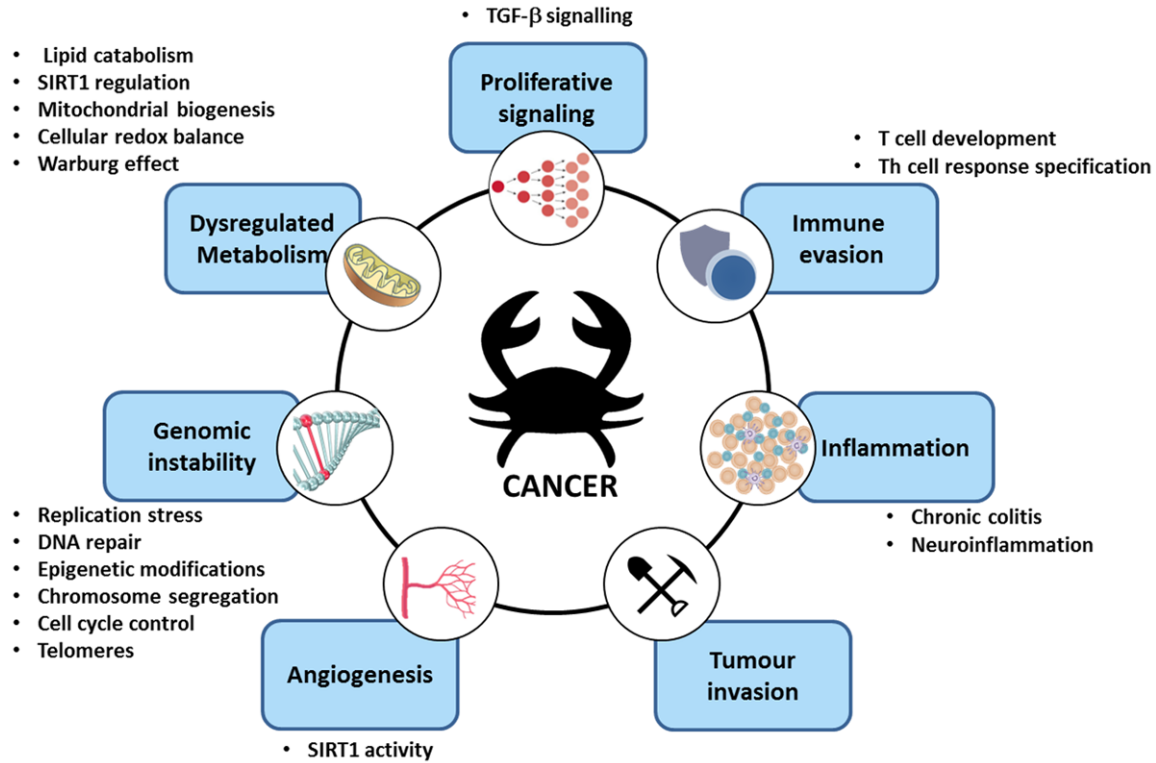

Figure 3. PARP-2 in the hallmarks of cancer. Schematic representation of the involvement of PARP-2 in biological processes commonly dysregulated in tumorigenesis.

stability and the development and use of PARP-2-specific inhibitors.

Role of PARP-2 in replication stress

DNA replication must be tightly regulated to prevent genomic instability and therefore carcinogenesis [53]. Indeed, impaired replication fork progression and increased replication-dependent DNA damage have been observed in early stages of tumour development [54, 55]. Furthermore, oncogene activation has been found to induce replication stress by various mechanisms [53]. Perturbations in replication can give rise to mutagenesis, genomic rearrangements and chromosome segregation defects [53]. Thus, a variety of checkpoints and DDR pathways act to detect and respond to replicative abnormalities [53, 56]. Replication stress is prevalent among cancers and it has been proposed as an additional hallmark of carcinogenesis, driving genomic instability and evasion of apoptosis [57].

While PARP-1 is known to protect stalled replication forks against degradation and acts to

recruit the DNA repair machinery required for fork restart [58-61], there is growing evidence for a role of PARP-2 therein. *PARP1*^{-/-} and/or *PARP-2*^{-/-} in SW480SN.3 human cells, abolishes homologous recombination (HR)-mediated restart of hydroxyurea-stalled replication forks [58]. Combined with a role of PARP-1 in Mre11 recruitment to stalled forks, it has been proposed that PARP-1 and PARP-2 cooperate in stalled fork detection and restart via Mre11-dependent initiation of HR [58].

Recent work in mouse erythroblasts reveals a specific role of PARP-2 in the replication stress response in erythropoiesis. *Parp-2*^{-/-}, but not *Parp-1*^{-/-}, mice display chronic anaemia in steady-state conditions and *Parp-2*^{-/-} erythroblasts exhibit various biomarkers of replication stress, including micronuclei formation, elevated γ H-2AX formation in S-phase, increased CHK1 phosphorylation and RPA phosphorylation and newborn lethality with *Parp-2/p21* double-knockout (**Table 2**) [25]. PARP-2 appears to play tissue-specific roles in processes characterised by high proliferation rates, similar to patterns observed in other mouse models defec-

PARP-2 and cancer

Table 2. PARP-2-deficient mouse models

Genotype	Developmental defects	Fertility defects	Spontaneous tumorigenesis	Ref.
Parp-2 ^{-/-}	Impaired thymopoiesis, adipogenesis, spermatogenesis, fetal liver erythropoiesis	Hypofertility, testicular hypoplasia, oligospermia	None	[13, 23-25, 51]
Parp-2 ^{-/-} Parp-1 ^{-/-}	Early embryonic lethality	NA	NA	[27]
Parp-2 ^{-/-} Atm ^{-/-}	Early embryonic lethality	NA	NA	[7]
Parp-2 ^{-/-} p53 ^{-/-}	Partial embryonic lethality	None	Early onset of T cell lymphoma	[51]
Parp-2 ^{-/-} p21 ^{-/-}	Newborn lethality due to impaired fetal liver erythropoiesis	NA	NA	[25]
Parp-2 ^{-/-} Xrcc5 ^{-/-}	Partial newborn lethality and growth retardation	NA	NA	[52]
Parp-2 ^{-/-} Prkdc ^{-/-}	Shortened lifespan and accumulation of telomere fusions similar to Parp-2 ^{-/-} Prkdc ^{-/-}	Unknown	50% thymic lymphoma similar to Parp-2 ^{-/-} Prkdc ^{-/-}	[52]
Parp-2 ^{-/-} H2afx ^{-/-}	Early embryonic lethality	NA	NA	[52]

NA, not applicable.

tive in the replication stress response, such as ATR hypomorphism [62]. Indeed, PARP-2-specific roles have been uncovered in spermatogenesis [23], thymopoiesis [24, 51] and haematopoietic stress responses [50] and PARP-2 was recently identified in a genome-wide RNAi screen for replication stress response genes [63]. Interestingly, PARP-2 plays an important role in hydroxyurea-induced replication stress in plants [64]. Together these recent findings point towards specific functions of PARP-2 in the replication stress response.

Role of PARP-2 in DNA repair

With the panoply of intrinsic and extrinsic sources of genotoxicity faced by cells everyday comes a similarly diverse gamut of lesions, ranging from base modifications and conversion to single- and double-strand breakage. In turn, cells have evolved a large range of DNA repair mechanisms, broadly classed as single-stranded DNA repair or double-stranded break repair [65]. Mutagenesis is critical for carcinogenesis and dysfunction of DNA repair mechanisms is an important source of genomic instability in cancer [66]. Conversely, these pathways also act to repair damage from chemo- and radiotherapy and thus cancer therapies have been developed to target cancer DNA repair defects, halt proliferation and induce apoptosis via DDR activation or potentiate existing treatments [67].

Single-stranded DNA repair is largely mediated by three major pathways: base excision repair (BER)/single-strand break repair (SSBR), nucleotide excision repair (NER) and mismatch repair (MMR). BER involves the recognition and excision of a damaged base by a DNA glycosylase to produce an apurinic/apymidinic (AP) site, followed by AP endonuclease 1 (APE1) mediated strand incision to produce a single-strand break (SSB). Pol β then catalyses gap filling and the nick is sealed by a ligase, either ligase I or the DNA ligase III/XRCC1 complex [68]. Although both PARP-1 and PARP-2 are considered to contribute in SSBR/BER, they exhibit specific interactions with the BER pathway and their roles appear to be spatiotemporally distinct. While both PARPs can bind to AP sites, DNA binding of PARP-2 is not regulated by autoPARylation [69]. *Parp-2*^{-/-} MEFs exhibit significantly slower repair of MNU-induced DNA strand breaks, similar to PARP-1-deficient cells

suggesting a non-redundant overlapping function of PARP-2 in BER [17]. In contrast, human A549 cells deficient in PARP-2 displayed only a slight reduction in initial SSBR rate upon hydrogen peroxide exposure, compared to a significant delay observed with PARP-1 deficiency, calling into question the role of PARP-2 in SSBR/BER [70]. While PARP-1 is recruited early and transiently to laser-microirradiated DNA, PARP-2 exhibits delayed persistent recruitment in a PARP-1 and PARylation-dependent manner [71]. Recent single-molecule AFM imaging studies of PARP-2 DNA binding have confirmed preferential recruitment to SSBs over DSBs and undamaged DNA [34] and Kd values measured for a range of DNA structures have shown that PARP-2 has highest affinity for flap-containing DNA [72]. In addition PARP-2, like PARP-3, is preferentially activated by 5' phosphorylated DNA breaks [73, 74]. Together, these findings argue for a role of PARP-2 in the recognition of later repair intermediates in SSBR.

PARP-1 and -2 have been found to differentially interact with multiple SSBR/BER factors (**Figure 1**) including the non-enzymatic scaffold protein XRCC1 [75]. XRCC1 is recruited to microirradiated DNA in a PARP-1, but not PARP-2 dependent manner [71, 76], acting to inhibit the dissociative automodification activities of both molecules and being PARylated itself on its BRCT1/2 domains by PARP-2 [17]. PARP-1 and 2 also interact with Pol β , FEN1 and DNA Ligase III (**Figure 1**) [17, 72], inhibiting the DNA synthetic and endonuclease activities of the former two proteins respectively. This inhibition can be relieved by PARP-1 but not PARP-2 PARylation but PARP-2 acts to abrogate the restorative polymerisation of PARP-1 [72]. Together these results suggest spatiotemporal segregation but mutually modifiable functions of PARP-1 and PARP-2 in SSBR/BER.

While recent data are uncovering a role of PARP-1 in NER and MMR [77-79], the role of PARP-2 therein remains unknown.

Double-strand break repair (DSBR) proceeds via two main pathways, non-homologous end-joining (NHEJ) and homologous recombination (HR). The presence of DSBs is signalled by the protein Ataxia telangiectasia mutated (ATM), a serine/threonine kinase, phosphorylating targets such as p53, CHK2, NBS1 and BRCA1 to initiate repair and cell cycle responses [80].

Double knockout mouse models of PARP-1 or PARP-2 with ATM (*Parp-1^{-/-}Atm^{-/-}* and *Parp-2^{-/-}Atm^{-/-}*) both result in early embryonic lethality (Table 2) [7, 81]. This may be due to the conversion of unrepaired spontaneous SSBs in hyperproliferative embryonic cells, into DSBs during replication and again going unrepaired due to ATM deficiency. GST-pulldowns of GST-ATM fusions have, however, revealed a physical interaction with PAR molecules and PARylated PARP-1 via putative PAR-binding domains on the ATM N-terminus (amino acid residues 99-120) and overlapping with the C-terminal PI3K domain [82]. The N-terminal PAR-binding domain contains a protein interaction domain critical for interaction with and phosphorylation of p53 [83] which suggests coupled functions of PARP-1 and downstream effectors of DSBR. Within the HR pathway, PARP-1 has been shown to interact with MRN complex components Mre11 and NBS1 [84] and combined with the aforementioned interactions of PARP-1, PARP-2 and Mre11 in replication stress, this could implicate PARP-2 in a new role in HR [58].

PARP-1 is known to act in conjunction with the ligation activity of the DNA ligase III/XRCC4 complex [85], in an alternative Ku-independent end-joining pathway, complementary to classical NHEJ, with competition between Ku and PARP-1 for DNA binding thought to mediate the switch between pathways [86]. Furthermore, class-switching recombination (CSR) of immunoglobulin genes has been demonstrated to involve activation-induced cytidine deaminase (AID)-induced PARP-1 activity. Here, PARP-1 is thought to promote joining of switch regions in a non-classical microhomology-mediated pathway [87], favoured in the absence of NHEJ proteins e.g. XRCC4 and DNA ligase IV [88]. AID-induced DSBs are a critical component of CSR, without which short-range recombination is abnormally frequent and chromosomal translocations with proto-oncogenes such as *c-myc* may arise [89]. Monitoring the frequency of IgH/*c-myc* translocations in *Parp-1^{-/-}* or *Parp-2^{-/-}* murine B-lymphocytes showed suppression of translocations by PARP-2 but not PARP-1 [87]. However, a mechanistic involvement of PARP-2 in NHEJ is at present unclear.

The recent development of new double-knockout mouse models has allowed the identification of interconnections between PARP-1 and PARP-2 with the DSBR machinery (Table 2). The

histone variant H2AX serves an important role in DSB detection and signalling and neither *Parp-1^{-/-}H2AX^{-/-}* nor *Parp-2^{-/-}H2AX^{-/-}* mice are viable [52, 90, 91]. In contrast, unlike PARP-1, PARP-2 deficiency combined with loss of the NHEJ factors Ku80 or DNA-PKcs, does not reveal any considerable exacerbation of phenotype [52].

PARP-2 in chromatin architecture and epigenetic modifications

Chromatin remodelling is actively involved in the DDR via modulation of accessibility of damaged sites to signalling and repair machinery. This has obvious implications for genome integrity as well as cellular senescence and cancer which involve DDR activation and alterations in chromatin architecture [92, 93]. Furthermore chromatin architectural changes, such as by histone modifications, form part of the nominal 'epigenetic landscape', the dysregulation of which is a hallmark of cancer [94]. Indeed, epigenetic therapy targeting reversible epigenetic marks, as opposed to irreversible tumorigenic mutations, is increasingly becoming a potential therapeutic strategy against cancer [95].

Early experiments found that nucleosomal PARylation resulted in chromatin decondensation, pointing towards a role of PARPs in chromatin architecture [96, 97]. PARP-1 and PARP-2 have both been shown to differentially PARylate the nucleosome with PARP-1 preferentially targeting the linker histone H1 while core histones H2A/H2B serve as a preferential substrate of PARP-2 [35, 98]. PARP-2-dependent PARylation also appears to have a role in facultative heterochromatin maintenance such as that in meiotic sex chromosome inactivation in male germ cells. Indeed, *Parp-2^{-/-}* murine pachytene spermatocytes display histone H4 hypoacetylation and H3K9 hypomethylation throughout the nucleus compared to wild-type cells [23].

PARP-2 has also been shown to be involved in heterochromatin reorganisation in endodermal differentiation via interactions with non-histone proteins heterochromatin protein 1 (HP1) proteins and transcriptional intermediary factor 1 β (TIF1 β) [9]. The HP1 family of proteins is involved in chromatin packing and heterochromatinisation-mediated gene repression [99]. TIF1 β is a co-repressor for the KRAB-transcriptional repression domain-containing family of

Zn-finger proteins and promotes transcriptional silencing involving HP1 binding and histone deacetylation [100-103]. PARP-2 has been shown to bind directly to HP1 α and HP1 β and with high affinity both directly to TIF1 β and indirectly via HP1 α . In comparison, PARP-1 demonstrates only weak binding to TIF1 β and HP1 β . Both PARP-1 and PARP-2 PARylate HP1 α but shRNA knockdowns demonstrate distinct roles in endodermal differentiation [9].

Together, these results point towards specific roles of PARP-2 in chromatin structure and function and establishment of the histone code and subcodes, distinct from PARP-1. Further studies are needed to elucidate the precise role of PARP-2 in these processes, which will allow the evaluation of PARP-2 as a potential target of epigenetic therapy for cancer.

PARP-2 in chromosome segregation

Centromeric and kinetochore integrity are crucial to faithful chromosome segregation in mitosis [104] and aneuploidy secondary to chromosomal instability and segregation defects is a common feature of cancers [105]. Both PARP-1 and PARP-2 exhibit cell cycle-dependent association with mammalian centromeres, albeit with different localisation. While PARP-1 occupies a diffuse centromeric distribution extending to the surrounding pericentric region, PARP-2 demonstrates sequence-independent accumulation at the centromere periphery, which increases with microtubule inhibitor treatment [14, 106]. Both PARP-1 and PARP-2 co-immunoprecipitate with the constitutive centromere proteins Cenpa and Cenpb and the spindle assembly checkpoint protein Bub3 (**Figure 1**), which are PARylated with DNA damage [14, 107]. Furthermore, *Parp-2*^{-/-} MEFs treated with the alkylating agent MNU exhibit G2/M arrest marked by polyploidy and chromosome mis-segregation, indicative of centromeric and kinetochore dysfunction [23, 27]. These findings argue for a role of PARP-2 distinct from but overlapping with that of PARP-1 in centromeric structure and function as well as checkpoint activation.

In addition to the aforementioned effects on mitotic cells, PARP-2-deficiency in mice also produces chromosome segregation defects at meiotic metaphase I in male gametogenesis [23]. The fidelity of meiotic chromosome segre-

gation is dependent on the integrity of chiasma formation between homologous chromosomes [108]. Concurrently, the accumulation of univalents in *Parp-2*^{-/-} metaphase I spermatocytes and in turn, aneuploid metaphase II cells was found against a backdrop of a 59% reduction in *Mlh1* foci formation, a marker of chiasmata sites, compared to wild-type controls. While mechanistically unclear, this segregation failure could be ascribed to PARP-2 deficiency marring centromeric heterochromatin integrity [27], as in somatic cells, or to putative roles of PARP-2 in resolution of recombination intermediates or meiotic spindle assembly [23].

PARP-2 in cell cycle regulation

The coupling of the aforementioned processes involved in the maintenance of genomic integrity with cell cycle progression and checkpoint controls, ensures the timely execution of events in cellular proliferation. Cell cycle dysregulation gives rise to the uncontrolled proliferation observed in cancers and checkpoint dysfunction can lead to inheritance of damaged DNA and chromosome segregation defects, thus producing genomic instability [109].

New data are beginning to shed light on potential roles of PARP-2 in the eukaryotic cell cycle. Loss of PARP-2 in mouse erythroid progenitors results in cell cycle arrest at the G2/M transition [25] and PARP-2 overexpression in human HEK293 cells delays G1 exit [10]. PARP-2 is found to cause PARylation-independent transcriptional repression of the promoters of various cell cycle-related genes including *p21*, *RB*, *E2F1* and *c-MYC* and this co-repressor activity involves recruitment of the histone deacetylases HDAC5 and HDAC7 and the H3K9 trimethyltransferase G9a [10]. *p21*, a cyclin-dependent kinase inhibitor, is an important cell cycle regulator, acting at both G1/S and G2/M transitions [110] and double knockout of PARP-2 and *p21* causes newborn lethality in mice suggesting a functional interaction between the two molecules [25]. Together with the interaction of PARP-2 with the spindle assembly checkpoint protein Bub3 [14], these findings point towards a role of PARP-2 in the coordination of cell cycle progression and checkpoint regulation. Further studies are necessary to elucidate the precise action of PARP-2 in these processes.

PARP-2 in telomere maintenance

Telomeres are double-stranded DNA tracts of short tandem repeats at chromosome termini and are maintained by telomerase [111]. In mammals, the repeat sequence is TTAGGG [112] and forms a length of around 10-15 kb at birth with a single-stranded 3' overhang of 50-150 nucleotides which may invade the telomeric duplex to form a lariat structure called the T-loop as well as a locally displaced single-stranded DNA tract called the D-loop [113]. The TTAGGG repeats associate with the multisubunit shelterin complex which protects the telomere from recognition as a DNA strand break and is also involved in maintaining the integrity thereof [114]. TRF2 is a core component of the shelterin complex and is involved in T-loop formation [115] as well as recruitment of proteins involved in telomeric protection and maintenance [111]. PARP-2 has been shown to physically interact with TRF2 (**Figure 1**) and inhibits TRF2 DNA-binding by both PARylation of its dimerisation domain and non-covalent competitive binding of PAR polymers to the TRF2 DBD [15]. Such regulation may serve to open the T-loop lariat to ease access of DNA repair machinery and/or modulate TRF2 binding partner interactions, pointing to a role of PARP-2 in telomeric integrity [15]. Indeed, PARP-2-deficient MEFs display hallmarks of telomeric dysfunction including increased frequency of metaphase chromosomal and chromatid breaks and TTAGGG-free ends despite normal telomere length [15].

Lagging strand replication occurs by a series of short DNA Okazaki fragments downstream of RNA primers, the most terminal of which is not replicated - the nominal 'end-replication problem' and thus with repeated rounds of replication, a cell's telomeres will gradually shorten [116] until a certain critical threshold is reached and a potent DDR is induced by the uncapped chromosomes which results in cellular senescence, thus setting a cap on the replicative potential of a cell [93, 117, 118]. However, some cells with dysfunctional checkpoints, such as inactivated Rb or p53 pathways in cancer cells, may continue to divide with marked genomic instability and accumulation of rearranged DNA, largely resulting in cell death in a period termed 'cellular crisis' [119]. A subset of these cells may reactivate telomere maintenance mechanisms via telomerase expression

[120] or ALT pathway activation [121], effectively immortalising the cell, an important hallmark of cancer [47]. Through its role in telomere integrity, PARP-2 may be an important therapeutic target in cancer.

Role of PARP-2 in proliferative signalling

The TGF β signalling pathway is an important 'tumour suppressor' pathway with roles in embryonic development and differentiation, morphogenesis and tissue homeostasis [122]. Regulation of downstream Smad signal transducers is an important point of control in the pathway. Proximity ligation assays and immunoprecipitation experiments revealed the induction of PARP-1/Smad3 and PARP-2/Smad2/3 complexes upon TGF β signalling [11]. Activation of the TGF β pathway was found to promote Smad3 PARylation and PARylated Smad3 and Smad4 co-precipitate with both PARP-1 and PARP-2 (**Figure 1**) [11]. PARP-2 overexpression has been found to repress the Smad3/4 promoter and PARP-2 siRNA knock-down results in increased expression of TGF β gene targets *fibronectin* and *Smad7*, concurrent with an inhibitory role of PARP-2 in the pathway [11]. Through regulation of TGF β signalling, these results point towards a role of PARP-2 in the control of proliferation and cell fate, but further studies are required to elucidate the functional role of PARP-2 in TGF β -dependent cell behaviour and tumorigenesis.

Role of PARP-2 in metabolism

The role of PARP-2, as of PARP-1, in metabolic regulation is becoming increasingly apparent. Both PARPs mediate diverse regulation of oxidative metabolism and mitochondrial biogenesis via the NAD⁺-dependent deacetylase SIRT1 of the Sirtuin family of proteins. SIRT1 regulates a range of transcription factors and cofactors including PPAR γ , p53, PGC-1 α and the FOXO family of transcription factors to regulate metabolic homeostasis in response to changing NAD⁺ levels in states of energetic stress such as fasting and exercise [123]. While loss of either PARP produces increased SIRT1 activity, PARP-1 and PARP-2 regulate SIRT1 via different mechanisms. PARP-1 deletion acts to relieve competition for intracellular NAD⁺, while shRNA-mediated depletion of PARP-2 produces little effect on NAD⁺ balance [124]. Instead, PARP-2 is found to bind directly to the SIRT1

proximal promoter where it acts to negatively regulate SIRT1 expression [26]. Due to SIRT1 derepression, *Parp-2*^{-/-} mice exhibit elevated SIRT1 expression with decreased acetylation of SIRT1 targets FOXO1 and PGC-1 α which are transcriptional regulators of mitochondrial bioenergetics and biogenesis [26]. Indeed *Parp-2* deletion in mice produces increased mitochondrial biogenesis with a shift towards oxidative metabolism and upregulation of genes involved in mitochondrial function and lipid oxidation such as *tpn1*, *SDH*, *UCP2*, *MCAD* and *PGC-1 α* [26]. Concurrently, PARP-2 knockout mice display a leaner phenotype marked by a predominance of lipid catabolism as an energy source and interestingly, are more protected against diet-induced obesity and insulin resistance with a high-fat diet [26]. This protection is at least in part due to increased energy expenditure but may also be due to a direct effect of PARP-2 on white adipose tissue (WAT). Like PARP-1, PARP-2 acts to positively regulate PPAR γ -dependent promoters to promote adipogenesis [13, 125]. *Parp-2*^{-/-} mice exhibit impaired adipocyte differentiation with reduced adipocyte size and decreased WAT deposition concomitant with downregulation of PPAR γ target genes [13]. PARP-2 mRNA is additionally regulated by the miR-149, producing upregulation of SIRT1 activity to promote mitochondrial function and biogenesis via PGC-1 α activation [126]. Related to the role of PARP-2 in mitochondrial bioenergetics, cellular redox balance also appears to be regulated by PARP-2. Syngeneic lung adenocarcinomas from *Parp-1*^{-/-} or *Parp2*^{-/-} mice are smaller and exhibit reduced proliferation rates imputed to an observed increase in autophagy and apoptosis secondary to increased oxidative stress. Indeed loss of either PARP produces downregulation of key antioxidant enzymes such as catalase [127].

PARP-2 has been found to regulate both hepatic and systemic lipid homeostasis and negatively regulates the promoter of SREBP1, an important transcriptional regulator of sterol biosynthesis [128]. *Parp-2*^{-/-} mice exhibit increased hepatic cholesterol levels and *Parp-2* shRNA knockdown in HepG2 cells shows upregulation of SREBP1-dependent genes [128]. *Parp-2* deletion also produces reduced serum HDL (high-density lipoprotein) levels, a known risk factor for cardiovascular disease [128,

129]. This may be ascribed to an observed decrease in expression of the ATP-binding cassette transporter ABCA1, which is involved in reverse cholesterol transport from peripheral cells to the liver [128, 130].

Cancers are marked by a characteristic metabolic reprogramming producing a switch from oxidative bioenergetics to a regime of aerobic glycolysis (Warburg effect) which balances energy requirements with biogenesis [131]. Tumour metabolism is also marked by extensive lipid anabolism and redox balance changes to regulate the generation of tumorigenic reactive oxygen species (ROS) [131]. From the above it is clear that PARP-2 has a net antagonistic action on mitochondrial function and thus pharmacological PARP-2 inhibition may produce a shift away from glycolytic tumour metabolism towards an oxidative programme. Furthermore, increased lipid catabolism and oxidative stress-induced apoptosis and autophagy may intensify the putative antitumorigenic effect of PARP-2 loss.

While *Parp-1*^{-/-} and *Parp-2*^{-/-} mice display similar metabolic changes, unlike *Parp-1* deletion, *Parp-2* knockout mice exhibit increased glucose intolerance due to pancreatic dysfunction marked by reduced islet size and fasting blood insulin [26]. *Parp-2*^{-/-} mice have a substantial loss of expression of the pancreatic transcription factor *pdx1*, imputed to upregulated pancreatic SIRT1 expression and consequent FOXO1 activation [26]. Thus, any consideration of selective PARP-2 inhibition will require better understanding of the exact mechanisms of PARP2-dependent metabolic regulation.

Role of PARP-2 in angiogenesis

Neovascularisation of tissues is a physiological response to tissue damage but is also an important process in tumour expansion, serving to adequately oxygenate and nourish the tumour, remove waste and to function as a route for metastasis [132]. The angiogenic effect of PARP-1 is well established [133-135]. Moreover, PARP inhibition using the PARP-1/PARP-2 inhibitor GPI 15427 [133] results in impaired endothelial cell proliferation, migration, adhesion and tube-formation in response to angiogenic growth factor stimulation by vascular endothelial growth factor (VEGF) [136] and placental growth factor (PIGF) [133, 137]

suggesting that some of the antiangiogenic effect of inhibition was ascribable to loss of PARP-2. The role of PARP-2 in the regulation of proangiogenic genes such as *Pecam-1*, *OPN* and *Hif-1 α* , known to be upregulated by PARP-1 [134, 138], has not as yet been investigated.

However, as aforementioned, loss of PARP-2 produces upregulation of SIRT1 activity in mice [26]. Aside from known metabolic roles, the NAD⁺-dependent deacetylase exerts a proangiogenic effect via multiple mechanisms including repression of the antiangiogenic transcription factor FOXO1 [139] and activation of the proangiogenic transcriptional regulator PGC-1 α [140, 141]. SIRT1 also regulates the Notch signalling pathway, an important controller of blood vessel patterning and growth [142], both by deacetylation and inactivation of signalling intermediates [140] and epigenetic changes in Notch target genes [143]. Further investigations will be necessary to characterise the effects of PARP2-selective inhibition in neovascularisation through its role in SIRT1 modulation.

Role of PARP-2 in inflammation

The tumorigenic role of the proinflammatory microenvironment of a cancer is being increasingly understood and is an important feature of cancer development [47]. A role of PARP-1 in the inflammatory response has been established for a range of disease models [144, 145], imputed to either a functional interaction with NF- κ B, an important transcriptional regulator of inflammation, or NAD⁺ depletion secondary to PARP overactivation [146, 147]. In contrast, far less is understood of the potential roles of PARP-2 therein and mechanisms thereof.

Current evidence demonstrates differential importance of PARP-2 in different inflammatory disease models. In secretagogue-induced murine models of acute pancreatitis, PARP-1 but not PARP-2 deficiency attenuates disease severity [145], whereas *Parp-2* knockdown, like non-specific PARP inhibition, reduces inflammation in IL-10-deficient mouse models of chronic colitis [148, 149]. More recently, it was shown that *Parp-2* deletion, like non-selective PARP-1/2 inhibition, abates neuroinflammation and neurological dysfunction in mouse models of multiple sclerosis [150, 151]. Further studies

are required to elucidate roles of PARP-2 in other inflammatory diseases and the mechanisms thereof.

Role of PARP-2 in immunomodulation and immune evasion

Despite considerable enthusiasm regarding the prospect of PARP inhibition in cancer therapy, little attention has been paid to the role of these proteins in the modulation of the immune response to neoplasia. In addition to tumour cells, the tumour microenvironment is composed of stromal cells and tumor-infiltrating immune cells of both innate and adaptive lineages [152]. These diverse cells communicate with one another by means of direct contact and/or indirect paracrine signaling mediated by soluble factors such as cytokines and chemokines. This intercellular signaling can drive immune responses which may either hinder or facilitate tumour growth [153]. Interestingly, PARP-1 and PARP-2 have been shown to play a role in both innate and adaptive immune responses [154-156]. One of the major players in the immune response to cancer is the T cell. Although peripheral T cell homeostasis appears unaffected by either PARP-1 or PARP-2-deficiency in mice [24], PARP-1 is implicated in the regulation of NFAT [157] and Foxp3 [158, 159] expression, transcription factors important in T cell development and function. In contrast, the role of PARP-2 in such immunoregulation is as yet unexplored. PARP-1-deficiency is also found to promote Th1 cell responses [156], whereas PARP-2 deletion in EAE mouse models reduces Th1 and Th17 cell infiltration in the central nervous system suggesting non-redundant roles of PARP-2 in modulating T cell responses [150]. While PARP-1 is dispensable for thymocyte development, PARP-2-deficiency is found to halve CD4⁺/CD8⁺ (double positive; DP) thymocyte cellularity, and produce impaired DP survival accompanied by a marked increase in DP sensitivity to apoptosis [24].

Recent studies of tumour transplantation in a BALB/c syngeneic tumour model demonstrate a reduction in lung adenocarcinoma growth in *Parp-1*^{-/-} host mice, and to a lesser extent in *Parp-2*^{-/-} host mice compared to wild-type [127, 160]. This effect may be mediated, at least in part, by modulation of the immune response against the tumour in the absence of either PARP-1 or PARP-2. Further studies are required

to understand the specific function of PARP-2 in immunomodulation and its role in tumour destruction and immune evasion. Although biological strategies directing the immune system against tumour cells are under extensive study, small-molecule approaches targeting intracellular signalling pathways [161] such as those mediated by PARP proteins, may represent a potential therapeutic approach to fighting cancer.

Future prospects for PARP-2-selective inhibition in cancer therapy

PARP inhibition for cancer therapy has classically focused on either one of two antitumorigenic mechanisms of action, either the potentiation of DNA-damaging chemo- or radiotherapy [162-165] or synthetic lethality in DSBR-deficient tumours which are thus dependent on SSB/BER and PARP [166-168]. However, most clinically trialled 'PARP inhibitors' show weak or no selectivity among the PARP superfamily and even major clinical candidates such as veliparib and olaparib show no discrimination between PARP-1 and PARP-2 [169]. The activity of such agents should thus be considered as the effect of either pan-PARP inhibition or in many cases, PARP-1/2 blockade. The search for selective inhibitors is important both for the specific targeting of the non-redundant functions of PARPs but also to reduce off-target effects.

The above account of the pleiotropic influence of PARP-2 in the hallmarks of cancer reveals a wide-ranging molecular network regulated by this ADP-ribosyltransferase. The critical role of PARP-2 in DNA repair and the results of double-knockout mouse models immediately suggests the potential utility of PARP-2-selective inhibition in radio- or chemopotential or synthetic lethality approaches to cancer therapy. In addition, the broadening roles of PARP-2 in genomic stability and the bias of its action for highly proliferative cells suggest that PARP-2 inhibition could also serve to resist tumour growth via exacerbation of replication stress, induction of chromosome mis-segregation and dysregulation of cancer epigenetics, cell cycle progression and telomere integrity. Furthermore, emerging roles of PARP-2 in regulation of the tumour suppressor TGF β signalling cascade may provide another means of halting tumour proliferation. Of great interest is also the func-

tion of PARP-2 in metabolism; the aforementioned biochemical, cellular and organismal effects of PARP-2 loss on metabolism point towards a shift in metabolic profile away from the neoplastic Warburg effect. It may be that in addition to multilateral genomic destabilisation, PARP-2 inhibition could additionally hinder tumour growth by establishment of a metabolic programme non-permissive for carcinogenesis. We speculate that the immunomodulatory and seemingly tissue-specific anti-inflammatory effect of PARP-2 deletion in mice combined with putative roles in angiogenesis could reveal that PARP-2 inhibition further impairs tumour development through deprivation of essential oxygenation, nutrition, immunoprotection and growth signals. In addition, functions of PARP-2 in tumour invasion need to be explored. From these heterogeneous effects in the hallmarks of cancer, we propose that pharmacological inhibition of PARP-2 may provide a multipronged attack on tumour physiology on a genomic, cellular and microenvironmental level. Further studies will be needed to characterise the expanding regulatory network of PARP-2 to inform the design of PARP-2-selective inhibitors and evaluate the therapeutic utility thereof. Greater specificity may even be achieved by pharmacological targeting of PARP-2 protein substrates, such as blockade of epitopes subject to PARP-2-mediated PARylation, permitting 'fine-tuning' of target molecule functionality. There is thus great unexplored potential for the selective inhibition of PARP-2 or its targets and future work will be needed to guide the development of novel therapeutics.

Acknowledgements

The JY laboratory is supported by grants from Spanish Ministerio de Economía y Competitividad (SAF2014-53467-R), Fundació La Marató de TV3 (20134130), and CIBERehd.

Disclosure of conflict of interest

None.

Address correspondence to: Dr. José Yélamos, Department of Immunology, Cancer Research Program, Institut Hospital del Mar d'Investigacions Mèdiques (IMIM), Barcelona Biomedical Research Park (PRBB), C/Dr. Aiguader, 88, 08003-Barcelona, Spain. Tel: +34 93 3160411; Fax: +34 93 3160410; E-mail: jyelamos@imim.es

References

- [1] Hottiger MO. Nuclear ADP-ribosylation and its role in chromatin plasticity, cell differentiation, and epigenetics. *Ann Rev Biochem* 2015; 84: 227-263.
- [2] Schreiber V, Dantzer F, Ame JC and De Murcia G. Poly(ADP-ribose): novel functions for an old molecule. *Nat Rev Mol Cell Biol* 2006; 7: 517-528.
- [3] Yélamos J, Schreiber V and Dantzer F. Toward specific functions of poly(ADP-ribose) polymerase-2. *Trends Mol Med* 2008; 14: 169-178.
- [4] Slade D, Dunstan MS, Barkauskaite E, Weston R, Lafite P, Dixon N, Ahel M, Leys D and Ahel I. The structure and catalytic mechanism of a poly(ADP-ribose) glycohydrolase. *Nature* 2011; 477: 616-620.
- [5] Oka S, Kato J and Moss J. Identification and characterization of a mammalian 39-kDa poly(ADP-ribose) glycohydrolase. *J Biol Chem* 2006; 281: 705-713.
- [6] Amé JC, Rolli V, Schreiber V, Niedergang C, Apioiu F, Decker P, Muller S, Höger T, Ménissier-de Murcia J and de Murcia G. PARP-2, A novel mammalian DNA damage-dependent poly(ADP-ribose) polymerase. *J Biol Chem* 1999; 274: 17860-17868.
- [7] Huber A, Bai P, de Murcia JM and de Murcia G. PARP-1, PARP-2 and ATM in the DNA damage response: functional synergy in mouse development. *DNA Repair (Amst)* 2004; 3: 1103-1108.
- [8] Boehler C and Dantzer F. PARP-3, a DNA-dependent PARP with emerging roles in double-strand break repair and mitotic progression. *Cell Cycle* 2011; 10: 1023-1024.
- [9] Quénet D, Gasser V, Fouillen L, Cammas F, Sanglier-Cianferani S, Losson R and Dantzer F. The histone subcode: poly(ADP-ribose) polymerase-1 (Parp-1) and Parp-2 control cell differentiation by regulating the transcriptional intermediary factor TIF1 β and the heterochromatin protein HP1 α . *FASEB J* 2008; 22: 3853-3865.
- [10] Liang YC, Hsu CY, Yao YL and Yang WM. PARP-2 regulates cell cycle-related genes through histone deacetylation and methylation independently of Poly(ADP-ribosylation). *Biochem Biophys Res Commun* 2013; 431: 58-64.
- [11] Dahl M, Maturi V, Lönn P, Papoutsoglou P, Zieba A, Vanlandewijck M, van der Heide LP, Watanabe Y, Söderberg O and Hottiger MO. Fine-Tuning of Smad Protein Function by Poly(ADP-Ribose) Polymerases and Poly(ADP-Ribose) Glycohydrolase during Transforming Growth Factor β Signaling. *PLoS One* 2014; 9: e103651-e103651.
- [12] Quénet D, Mark M, Govin J, Van Dorsselear A, Schreiber V, Khochbin S and Dantzer F. Parp2 is required for the differentiation of post-meiotic germ cells: identification of a spermatid-specific complex containing Parp1, Parp2, TP2 and HSPA2. *Exp Cell Res* 2009; 315: 2824-2834.
- [13] Bai P, Houten SM, Huber A, Schreiber V, Watanabe M, Kiss B, De Murcia G, Auwerx J and Ménissier-de Murcia J. Peroxisome proliferator-activated receptor (PPAR)-2 controls adipocyte differentiation and adipose tissue function through the regulation of the activity of the retinoid X receptor/PPAR γ heterodimer. *J Biol Chem* 2007; 282: 37738-37746.
- [14] Saxena A, Wong LH, Kalitsis P, Earle E, Shaffer LG and Choo KH. Poly(ADP-ribose) polymerase 2 localizes to mammalian active centromeres and interacts with PARP-1, Cenpa, Cenpb and Bub3, but not Cenpc. *Hum Mol Genet* 2002; 11: 2319-2329.
- [15] Dantzer F, Giraud-Panis MJ, Jaco I, Amé JC, Schultz I, Blasco M, Koering CE, Gilson E, Ménissier-de Murcia J and de Murcia G. Functional interaction between poly(ADP-ribose) polymerase 2 (PARP-2) and TRF2: PARP activity negatively regulates TRF2. *Mol Cell Biol* 2004; 24: 1595-1607.
- [16] Maeda Y, Hunter TC, Loudy DE, Davé V, Schreiber V and Whitsett JA. PARP-2 interacts with TTF-1 and regulates expression of surfactant protein-B. *J Biol Chem* 2006; 281: 9600-9606.
- [17] Schreiber V, Amé JC, Dollé P, Schultz I, Rinaldi B, Fraulob V, Ménissier-de Murcia J and de Murcia G. Poly(ADP-ribose) polymerase-2 (PARP-2) is required for efficient base excision DNA repair in association with PARP-1 and XRCC1. *J Biol Chem* 2002; 277: 23028-23036.
- [18] Von Kobbe C, Harrigan JA, Schreiber V, Stiegler P, Piotrowski J, Dawut L and Bohr VA. Poly(ADP-ribose) polymerase 1 regulates both the exonuclease and helicase activities of the Werner syndrome protein. *Nucleic Acids Res* 2004; 32: 4003-4014.
- [19] Meder VS, Boeglin M, De Murcia G and Schreiber V. PARP-1 and PARP-2 interact with nucleophosmin/B23 and accumulate in transcriptionally active nucleoli. *J Cell Sci* 2005; 118: 211-222.
- [20] Gibson BA, Zhang Y, Jiang H, Hussey KM, Shrimp JH, Lin H, Schwede F, Yu Y and Kraus WL. Chemical genetic discovery of PARP targets reveals a role for PARP-1 in transcription elongation. *Science* 2016; 353: 45-50.
- [21] Zhang Y, Wang J, Ding M and Yu Y. Site-specific characterization of the Asp- and Glu-ADP-ribosylated proteome. *Nat Methods* 2013; 10: 981-984.

PARP-2 and cancer

- [22] Jungmichel S, Rosenthal F, Altmeyer M, Lukas J, Hottiger MO and Nielsen ML. Proteome-wide identification of Poly(ADP-ribosyl)ation targets in different genotoxic stress responses. *Mol Cell* 2013; 52: 272-285.
- [23] Dantzer F, Mark M, Quenet D, Scherthan H, Huber A, Liebe B, Monaco L, Chicheportiche A, Sassone-Corsi P and De Murcia G. Poly(ADP-ribose) polymerase-2 contributes to the fidelity of male meiosis I and spermiogenesis. *Proc Natl Acad Sci U S A* 2006; 103: 14854-14859.
- [24] Yélamos J, Monreal Y, Saenz L, Aguado E, Schreiber V, Mota R, Fuente T, Minguela A, Parrilla P and De Murcia G. PARP-2 deficiency affects the survival of CD4+ CD8+ double-positive thymocytes. *EMBO J* 2006; 25: 4350-4360.
- [25] Farrés J, Llacuna L, Martín-Caballero J, Martínez C, Lozano JJ, Ampurdanés C, López-Contreras AJ, Florensa L, Navarro J, Ottina E, Dantzer F, Schreiber V, Villunger A, Fernández-Capetillo O, Yélamos J. PARP-2 sustains erythropoiesis in mice by limiting replicative stress in erythroid progenitors. *Cell Death Differ* 2015; 22: 1144-57.
- [26] Bai P, Canto C, Brunyánszki A, Huber A, Szántó M, Cen Y, Yamamoto H, Houten SM, Kiss B and Oudart H. PARP-2 regulates SIRT1 expression and whole-body energy expenditure. *Cell Metabol* 2011; 13: 450-460.
- [27] de Murcia JM, Ricoul M, Tartier L, Niedergang C, Huber A, Dantzer F, Schreiber V, Amé JC, Dierich A and LeMeur M. Functional interaction between PARP-1 and PARP-2 in chromosome stability and embryonic development in mouse. *EMBO J* 2003; 22: 2255-2263.
- [28] Sonnenblick A, De Azambuja E, Azim HA Jr and Piccart M. An update on PARP inhibitors - moving to the adjuvant setting. *Nat Rev Clin Oncol* 2015; 12: 27-41.
- [29] O'Connor MJ. Targeting the DNA damage response in cancer. *Mol Cell* 2015; 60: 547-560.
- [30] Daniels CM, Ong SE and Leung AK. The promise of proteomics for the study of ADP-ribosylation. *Mol Cell* 2015; 58: 911-924.
- [31] Heilig R, Eckenberg R, Petit JL, Fonknechten N, Da Silva C, Cattolico L, Levy M, Barbe V, de Bernardinis V and Ureta-Vidal A. The DNA sequence and analysis of human chromosome 14. *Nature* 2003; 421: 601-607.
- [32] Riccio AA, Cingolani G and Pascal JM. PARP-2 domain requirements for DNA damage-dependent activation and localization to sites of DNA damage. *Nucleic Acids Res* 2016; 44: 1691-702.
- [33] Langelier MF, Servent KM, Rogers EE and Pascal JM. A third zinc-binding domain of human poly(ADP-ribose) polymerase-1 coordinates DNA-dependent enzyme activation. *J Biol Chem* 2008; 283: 4105-4114.
- [34] Sukhanova MV, Abrakhi S, Joshi V, Pastre D, Kutuzov MM, Anarbaev RO, Curmi PA, Hamon L and Lavrik OI. Single molecule detection of PARP1 and PARP2 interaction with DNA strand breaks and their Poly(ADP-ribosyl)ation using high-resolution AFM imaging. *Nucleic Acids Res* 2015; 44: e60.
- [35] Haenni SS, Hassa PO, Altmeyer M, Fey M, Imhof R and Hottiger MO. Identification of lysines 36 and 37 of PARP-2 as targets for acetylation and auto-ADP-ribosylation. *Int J Biochem Cell Biol* 2008; 40: 2274-2283.
- [36] Benchoua A, Couriaud C, Guégan C, Tartier L, Couvert P, Friocourt G, Chelly J, Méniessier-de Murcia J and Onténiente B. Active caspase-8 translocates into the nucleus of apoptotic cells to inactivate poly(ADP-ribose) polymerase-2. *J Biol Chem* 2002; 277: 34217-34222.
- [37] Eguchi Y, Shimizu S and Tsujimoto Y. Intracellular ATP levels determine cell death fate by apoptosis or necrosis. *Cancer research* 1997; 57: 1835-1840.
- [38] Amé JC, Spenlehauer C and de Murcia G. The PARP superfamily. *Bioessays* 2004; 26: 882-893.
- [39] Aoyagi-Scharber M, Gardberg AS, Yip BK, Wang B, Shen Y and Fitzpatrick PA. Structural basis for the inhibition of poly(ADP-ribose) polymerases 1 and 2 by BMN 673, a potent inhibitor derived from dihydropyridophthalazinone. *Acta Crystallogr F Struct Biol Commun* 2014; 70: 1143-1149.
- [40] Hunter SM, Rowley SM, Clouston D, Li J, Lupat R, Krishnananthan N, Risbridger G, Taylor R, Bolton D and Campbell IG. Searching for candidate genes in familial BRCA1 mutation carriers with prostate cancer. *Urol Oncol* 2016; 34: 120, e9-16.
- [41] Johnson AM, Zuhlke KA, Plotts C, McDonnell SK, Middha S, Riska SM, Schaid DJ, Thibodeau SN, Douglas JA and Cooney KA. Mutational landscape of candidate genes in familial prostate cancer. *Prostate* 2014; 74: 1371-1378.
- [42] Osorio A, Milne RL, Kuchenbaecker K, Vaclová T, Pita G, Alonso R, Peterlongo P, Blanco I, De la Hoya M and Duran M. DNA glycosylases involved in base excision repair may be associated with cancer risk in BRCA1 and BRCA2 mutation carriers. *PLoS Genet* 2014; 10: e1004256-e1004256.
- [43] Popanda O, Seibold P, Nikolov I, Oakes CC, Burwinkel B, Hausmann S, Flesch-Janys D, Plass C, Chang-Claude J and Schmezer P. Germline variants of base excision repair genes and breast cancer: A polymorphism in DNA polymerase gamma modifies gene expression and breast cancer risk. *Int J Cancer* 2013; 132: 55-62.

PARP-2 and cancer

- [44] Xie H, Gong Y, Dai J, Wu X and Gu J. Genetic variations in base excision repair pathway and risk of bladder cancer: A case-control study in the United States. *Mol Carcinog* 2015; 54: 50-57.
- [45] Gao Y, Hayes RB, Huang WY, Caporaso NE, Burdette L, Yeager M, Chanock SJ and Berndt SI. DNA repair gene polymorphisms and tobacco smoking in the risk for colorectal adenomas. *Carcinogenesis* 2011; 32: 882-7.
- [46] Seibold P, Schmezer P, Behrens S, Michailidou K, Bolla MK, Wang Q, Flesch-Janys D, Nevanlinna H, Fagerholm R and Aittomäki K. A polymorphism in the base excision repair gene PARP2 is associated with differential prognosis by chemotherapy among postmenopausal breast cancer patients. *BMC cancer* 2015; 15: 1-1.
- [47] Hanahan D and Weinberg RA. Hallmarks of cancer: the next generation. *Cell* 2011; 144: 646-674.
- [48] Shen Z. Genomic instability and cancer: an introduction. *J Mol Cell Biol* 2011; 3: 1-3.
- [49] Aguilera A and García-Muse T. Causes of genome instability. *Ann Rev Genet* 2013; 47: 1-32.
- [50] Farrés J, Martín-Caballero J, Martínez C, Lozano JJ, Llacuna L, Ampurdanés C, Ruiz-Herguido C, Dantzer F, Schreiber V and Villunger A. Parp-2 is required to maintain hematopoiesis following sublethal γ -irradiation in mice. *Blood* 2013; 122: 44-54.
- [51] Nicolas L, Martinez C, Baro C, Rodriguez M, Baroja-Mazo A, Sole F, Flores JM, Ampurdanes C, Dantzer F and Martin-Caballero J. Loss of poly(ADP-ribose) polymerase-2 leads to rapid development of spontaneous T-cell lymphomas in p53-deficient mice. *Oncogene* 2010; 29: 2877-2883.
- [52] Ghosh R, Roy S, Kamyab J, Dantzer F and Franco S. Common and unique genetic interactions of the poly(ADP-ribose) polymerases PARP1 and PARP2 with DNA double-strand break repair pathways. *DNA Repair (Amst)* 2016; 45: 56-62.
- [53] Gaillard H, García-Muse T and Aguilera A. Replication stress and cancer. *Nat Rev Cancer* 2015; 15: 276-289.
- [54] Bartkova J, Rezaei N, Liontos M, Karakaidos P, Kletsas D, Issaeva N, Vassiliou LV, Kolettas E, Niforou K and Zoumpourlis VC. Oncogene-induced senescence is part of the tumorigenesis barrier imposed by DNA damage checkpoints. *Nature* 2006; 444: 633-637.
- [55] Di Micco R, Fumagalli M, Cicalese A, Piccinin S, Gasparini P, Luise C, Schurra C, Nuciforo PG, Bensimon A and Maestro R. Oncogene-induced senescence is a DNA damage response triggered by DNA hyper-replication. *Nature* 2006; 444: 638-642.
- [56] Mazouzi A, Velimezi G and Loizou JI. DNA replication stress: causes, resolution and disease. *Exp Cell Res* 2014; 329: 85-93.
- [57] Macheret M and Halazonetis TD. DNA replication stress as a hallmark of cancer. *Ann Rev Pathol* 2015; 10: 425-448.
- [58] Bryant HE, Petermann E, Schultz N, Jemth AS, Loseva O, Issaeva N, Johansson F, Fernandez S, McGlynn P and Helleday T. PARP is activated at stalled forks to mediate Mre11-dependent replication restart and recombination. *EMBO J* 2009; 28: 2601-2615.
- [59] Ying S, Chen Z, Medhurst AL, Neal JA, Bao Z, Mortusewicz O, McGouran J, Song X, Shen H and Hamdy FC. DNA-PKcs and PARP1 bind to unresected stalled DNA replication forks where they recruit XRCC1 to mediate repair. *Cancer Res* 2016; 76: 1078-1088.
- [60] Ying S, Hamdy FC and Helleday T. Mre11-dependent degradation of stalled DNA replication forks is prevented by BRCA2 and PARP1. *Cancer Res* 2012; 72: 2814-2821.
- [61] Chaudhuri AR, Callen E, Ding X, Gogola E, Duarte AA, Lee JE, Wong N, Lafarga V, Calvo JA and Panzarino NJ. Replication fork stability confers chemoresistance in BRCA-deficient cells. *Nature* 2016; 535: 382-387.
- [62] Murga M, Bunting S, Montaña MF, Soria R, Mulero F, Cañamero M, Lee Y, McKinnon PJ, Nussenzweig A and Fernandez-Capetillo O. A mouse model of ATR-Seckel shows embryonic replicative stress and accelerated aging. *Nat Genet* 2009; 41: 891-898.
- [63] Kavanaugh G, Ye F, Mohni KN, Luzwick JW, Glick G and Cortez D. A whole genome RNAi screen identifies replication stress response genes. *DNA Repair (Amst)* 2015; 35: 55-62.
- [64] Rybaczek D. Hydroxyurea-induced replication stress causes poly(ADP-ribose) polymerase-2 accumulation and changes its intranuclear location in root meristems of *Vicia faba*. *J Plant Physiol* 2016; 198: 89-102.
- [65] Ciccio A and Elledge SJ. The DNA damage response: making it safe to play with knives. *Mol Cell* 2010; 40: 179-204.
- [66] Jeggo PA, Pearl LH and Carr AM. DNA repair, genome stability and cancer: a historical perspective. *Nat Rev Cancer* 2016; 16: 35-42.
- [67] Gavande NS, VanderVere-Carozza PS, Hinshaw HD, Jalal SI, Sears CR, Pawelczak KS and Turchi JJ. DNA repair targeted therapy: The past or future of cancer treatment? *Pharmacol Ther* 2016; 160: 65-83.
- [68] Kim YJ and Wilson lli DM. Overview of base excision repair biochemistry. *Curr Mol Pharmacol* 2012; 5: 3-3.
- [69] Kutuzov MM, Khodyreva SN, Ilina ES, Sukhanova MV, Ame JC and Lavrik OI. Interaction of PARP-2 with AP site containing DNA. *Biochimie* 2015; 112: 10-19.

PARP-2 and cancer

- [70] Fisher AE, Hochegger H, Takeda S and Caldecott KW. Poly(ADP-ribose) polymerase 1 accelerates single-strand break repair in concert with poly(ADP-ribose) glycohydrolase. *Mol Cell Biol* 2007; 27: 5597-5605.
- [71] Mortusewicz O, Amé JC, Schreiber V and Leonhardt H. Feedback-regulated Poly(ADP-ribosylation) by PARP-1 is required for rapid response to DNA damage in living cells. *Nucleic Acids Res* 2007; 35: 7665-7675.
- [72] Kutuzov MM, Khodyreva SN, Amé JC, Ilina ES, Sukhanova MV, Schreiber V and Lavrik OI. Interaction of PARP-2 with DNA structures mimicking DNA repair intermediates and consequences on activity of base excision repair proteins. *Biochimie* 2013; 95: 1208-1215.
- [73] Langelier MF, Riccio AA and Pascal JM. PARP-2 and PARP-3 are selectively activated by 5' phosphorylated DNA breaks through an allosteric regulatory mechanism shared with PARP-1. *Nucleic Acids Res* 2014; 42: 7762-7775.
- [74] Talhaoui I, Lebedeva NA, Zarkovic G, Saint-Pierre C, Kutuzov MM, Sukhanova MV, Matkarimov BT, Gasparutto D, Saparbaev MK and Lavrik OI. Poly(ADP-ribose) polymerases covalently modify strand break termini in DNA fragments in vitro. *Nucleic Acids Res* 2016; [Epub ahead of print].
- [75] Caldecott KW. XRCC1 and DNA strand break repair. *DNA Repair* 2003; 2: 955-969.
- [76] El-Khamisy SF, Masutani M, Suzuki H and Caldecott KW. A requirement for PARP-1 for the assembly or stability of XRCC1 nuclear foci at sites of oxidative DNA damage. *Nucleic Acids Res* 2003; 31: 5526-5533.
- [77] Liu Y, Kadyrov FA and Modrich P. PARP-1 enhances the mismatch-dependence of 5'-directed excision in human mismatch repair in vitro. *DNA Repair (Amst)* 2011; 10: 1145-1153.
- [78] Pines A, Vrouwe MG, Marteiijn JA, Typas D, Luijsterburg MS, Cansoy M, Hensbergen P, Deelder A, de Groot A and Matsumoto S. PARP1 promotes nucleotide excision repair through DDB2 stabilization and recruitment of ALC1. *Jo Cell Biol* 2012; 199: 235-249.
- [79] Robu M, Shah RG, Petitclerc N, Brind'Amour J, Kandan-Kulangara F and Shah GM. Role of poly(ADP-ribose) polymerase-1 in the removal of UV-induced DNA lesions by nucleotide excision repair. *Proc Natl Acad Sci U S A* 2013; 110: 1658-1663.
- [80] Hickson I, Zhao Y, Richardson CJ, Green SJ, Martin NM, Orr AI, Reaper PM, Jackson SP, Curtin NJ and Smith GC. Identification and characterization of a novel and specific inhibitor of the ataxia-telangiectasia mutated kinase ATM. *Cancer Res* 2004; 64: 9152-9159.
- [81] Ménissier-de Murcia J, Mark M, Wendling O, Wynshaw-Boris A and de Murcia G. Early Embryonic Lethality in PARP-1 AtmDouble-Mutant Mice Suggests a Functional Synergy in Cell Proliferation during Development. *Mol Cell Biol* 2001; 21: 1828-1832.
- [82] Haince JF, Kozlov S, Dawson VL, Dawson TM, Hendzel MJ, Lavin MF and Poirier GG. Ataxia telangiectasia mutated (ATM) signaling network is modulated by a novel poly(ADP-ribose)-dependent pathway in the early response to DNA-damaging agents. *J Biol Chem* 2007; 282: 16441-16453.
- [83] Fernandes N, Sun Y, Chen S, Paul P, Shaw RJ, Cantley LC and Price BD. DNA damage-induced association of ATM with its target proteins requires a protein interaction domain in the N terminus of ATM. *J Biol Chem* 2005; 280: 15158-15164.
- [84] Haince JF, McDonald D, Rodrigue A, Déry U, Masson JY, Hendzel MJ and Poirier GG. PARP1-dependent kinetics of recruitment of MRE11 and NBS1 proteins to multiple DNA damage sites. *J Biol Chem* 2008; 283: 1197-1208.
- [85] Audebert M, Salles B and Calsou P. Involvement of poly(ADP-ribose) polymerase-1 and XRCC1/DNA ligase III in an alternative route for DNA double-strand breaks rejoining. *J Biol Chem* 2004; 279: 55117-55126.
- [86] Wang M, Wu W, Wu W, Rosidi B, Zhang L, Wang H and Iliakis G. PARP-1 and Ku compete for repair of DNA double strand breaks by distinct NHEJ pathways. *Nucleic Acids Res* 2006; 34: 6170-6182.
- [87] Robert I, Dantzer F and Reina-San-Martin B. Parp1 facilitates alternative NHEJ, whereas Parp2 suppresses IgH/c-myc translocations during immunoglobulin class switch recombination. *J Exp Med* 2009; 206: 1047-1056.
- [88] Yan CT, Boboila C, Souza EK, Franco S, Hickenell TR, Murphy M, Gumaste S, Geyer M, Zarrin AA and Manis JP. IgH class switching and translocations use a robust non-classical end-joining pathway. *Nature* 2007; 449: 478-482.
- [89] Robbiani DF and Nussenzweig MC. Chromosome translocation, B cell lymphoma, and activation-induced cytidine deaminase. *Ann Rev Pathol* 2013; 8: 79-103.
- [90] Kinner A, Wu W, Staudt C and Iliakis G. γ -H2AX in recognition and signaling of DNA double-strand breaks in the context of chromatin. *Nucleic Acids Res* 2008; 36: 5678-5694.
- [91] Orsburn B, Escudero B, Prakash M, Gesheva S, Liu G, Huso DL and Franco S. Differential requirement for H2AX and 53BP1 in organismal development and genome maintenance in the absence of poly (ADP) ribosyl polymerase 1. *Mol Cell Biol* 2010; 30: 2341-2352.

PARP-2 and cancer

- [92] Sulli G, Di Micco R, d'Adda di Fagagna F. Crosstalk between chromatin state and DNA damage response in cellular senescence and cancer. *Nat Rev Cancer* 2012; 12: 709-720.
- [93] d'Adda di Fagagna F, Reaper PM, Clay-Farrace L, Fiegler H, Carr P, von Zglinicki T, Saretzki G, Carter NP and Jackson SP. A DNA damage checkpoint response in telomere-initiated senescence. *Nature* 2003; 426: 194-198.
- [94] Sharma S, Kelly TK and Jones PA. Epigenetics in cancer. *Carcinogenesis* 2010; 31: 27-36.
- [95] Ahuja N, Sharma AR and Baylin SB. Epigenetic therapeutics: a new weapon in the war against cancer. *Ann Rev Med* 2016; 67: 73-89.
- [96] Poirier GG, De Murcia G, Jongstra-Bilen J, Niedergang C and Mandel P. Poly(ADP-ribosylation) of polynucleosomes causes relaxation of chromatin structure. *Proc Natl Acad Sci U S A* 1982; 79: 3423-3427.
- [97] Huletsky A, De Murcia G, Muller S, Hengartner M, Menard L, Lamarre D and Poirier GG. The effect of poly(ADP-ribosylation) on native and H1-depleted chromatin. A role of poly(ADP-ribosylation) on core nucleosome structure. *J Biol Chem* 1989; 264: 8878-8886.
- [98] Bürkle A. Poly(ADP-Ribosyl)ation. US: Springer; 2008.
- [99] Nielsen AL, Oulad-Abdelghani M, Ortiz JA, Remboutsika E, Chambon P and Losson R. Heterochromatin formation in mammalian cells: interaction between histones and HP1 proteins. *Mol Cell* 2001; 7: 729-739.
- [100] Nielsen AL, Ortiz JA, You J, Oulad-Abdelghani M, Khechumian R, Gansmuller A, Chambon P and Losson RG. Interaction with members of the heterochromatin protein 1 (HP1) family and histone deacetylation are differentially involved in transcriptional silencing by members of the TIF1 family. *EMBO J* 1999; 18: 6385-6395.
- [101] Le Douarin B, Nielsen AL, Garnier JM, Ichinose H, Jeanmougin F, Losson R and Chambon P. A possible involvement of TIF1 alpha and TIF1 beta in the epigenetic control of transcription by nuclear receptors. *EMBO J* 1996; 15: 6701-6701.
- [102] Friedman JR, Fredericks WJ, Jensen DE, Speicher DW, Huang XP, Neilson EG and Rauscher FJ. KAP-1, a novel corepressor for the highly conserved KRAB repression domain. *Genes Dev* 1996; 10: 2067-2078.
- [103] Cammas F, Herzog M, Lerouge T, Chambon P and Losson R. Association of the transcriptional corepressor TIF1 β with heterochromatin protein 1 (HP1): an essential role for progression through differentiation. *Genes Dev* 2004; 18: 2147-2160.
- [104] Westhorpe FG and Straight AF. Functions of the centromere and kinetochore in chromosome segregation. *Curr Opin Cell Biol* 2013; 25: 334-340.
- [105] Rajagopalan H and Lengauer C. Aneuploidy and cancer. *Nature* 2004; 432: 338-341.
- [106] Earle E, Saxena A, MacDonald A, Hudson DF, Shaffer LG, Saffery R, Cancilla MR, Cutts SM, Howman E and Choo KH. Poly(ADP-ribose) polymerase at active centromeres and neocentromeres at metaphase. *Hum Mol Genet* 2000; 9: 187-194.
- [107] Saxena A, Saffery R, Wong LH, Kalitsis P and Choo KH. Centromere proteins Cenpa, Cenpb, and Bub3 interact with poly(ADP-ribose) polymerase-1 protein and are poly (ADP-ribosylated). *J Biol Chem* 2002; 277: 26921-26926.
- [108] Vogt E, Kirsch-Volders M, Parry J and Eichenlaub-Ritter U. Spindle formation, chromosome segregation and the spindle checkpoint in mammalian oocytes and susceptibility to meiotic error. *Mutat Res* 2008; 651: 14-29.
- [109] Diaz-Moralli S, Tarrado-Castellarnau M, Miranda A and Cascante M. Targeting cell cycle regulation in cancer therapy. *Pharmacol Ther* 2013; 138: 255-271.
- [110] Niculescu AB, Chen X, Smeets M, Hengst L, Prives C and Reed SI. Effects of p21Cip1/Waf1 at both the G1/S and the G2/M cell cycle transitions: pRb is a critical determinant in blocking DNA replication and in preventing endoreduplication. *Mol Cell Biol* 1998; 18: 629-643.
- [111] Palm W and de Lange T. How shelterin protects mammalian telomeres. *Ann Rev Genet* 2008; 42: 301-334.
- [112] Morin GB. The human telomere terminal transferase enzyme is a ribonucleoprotein that synthesizes TTAGGG repeats. *Cell* 1989; 59: 521-529.
- [113] Griffith JD, Comeau L, Rosenfield S, Stansel RM, Bianchi A, Moss H and De Lange T. Mammalian telomeres end in a large duplex loop. *Cell* 1999; 97: 503-514.
- [114] Sfeir A and de Lange T. Removal of shelterin reveals the telomere end-protection problem. *Science* 2012; 336: 593-597.
- [115] Stansel RM, de Lange T and Griffith JD. T-loop assembly in vitro involves binding of TRF2 near the 3' telomeric overhang. *EMBO J* 2001; 20: 5532-5540.
- [116] Ohki R, Tsurimoto T and Ishikawa F. In vitro reconstitution of the end replication problem. *Mol Cell Biol* 2001; 21: 5753-5766.
- [117] Hayflick L. The limited in vitro lifetime of human diploid cell strains. *Exp Cell Res* 1965; 37: 614-636.
- [118] Herbig U, Jobling WA, Chen BP, Chen DJ and Sedivy JM. Telomere shortening triggers senescence of human cells through a pathway involving ATM, p53, and p21 CIP1, but not p16 INK4a. *Mol Cell* 2004; 14: 501-513.

PARP-2 and cancer

- [119] Chang S, Khoo CM, Naylor ML, Maser RS and DePinho RA. Telomere-based crisis: functional differences between telomerase activation and ALT in tumor progression. *Genes Dev* 2003; 17: 88-100.
- [120] Counter CM, Avilion AA, LeFeuvre CE, Stewart NG, Greider CW, Harley CB and Bacchetti S. Telomere shortening associated with chromosome instability is arrested in immortal cells which express telomerase activity. *EMBO J* 1992; 11: 1921-1921.
- [121] Bollmann FM. Targeting ALT: the role of alternative lengthening of telomeres in pathogenesis and prevention of cancer. *Cancer Treat Rev* 2007; 33: 704-709.
- [122] Weiss A and Attisano L. The TGFbeta superfamily signaling pathway. *Wiley Interdiscip Rev Dev Biol* 2013; 2: 47-63.
- [123] Houtkooper RH, Cantó C, Wanders RJ and Auwerx J. The secret life of NAD⁺: an old metabolite controlling new metabolic signaling pathways. *Endocr Rev* 2010; 31: 194-223.
- [124] Bai P, Cantó C, Oudart H, Brunyánszki A, Cen Y, Thomas C, Yamamoto H, Huber A, Kiss B and Houtkooper RH. PARP-1 inhibition increases mitochondrial metabolism through SIRT1 activation. *Cell Metab* 2011; 13: 461-468.
- [125] Erener S, Hesse M, Kostadinova R and Hottiger MO. Poly(ADP-ribose) polymerase-1 (PARP1) controls adipogenic gene expression and adipocyte function. *Mol Endocrinol* 2011; 26: 79-86.
- [126] Mohamed JS, Hajira A, Pardo PS and Boriek AM. MicroRNA-149 inhibits PARP-2 and promotes mitochondrial biogenesis via SIRT1/PGC-1 α network in skeletal muscle. *Diabetes* 2014; 63: 1546-1559.
- [127] Mateu-Jiménez M, Cucarull-Martínez B, Yelamos J and Barreiro E. Reduced tumor burden through increased oxidative stress in lung adenocarcinoma cells of PARP-1 and PARP-2 knockout mice. *Biochimie* 2016; 121: 278-286.
- [128] Szántó M, Brunyánszki A, Márton J, Vámosi G, Nagy L, Fodor T, Kiss B, Virág L, Gergely P and Bai P. Deletion of PARP-2 induces hepatic cholesterol accumulation and decrease in HDL levels. *Biochim Biophys Acta* 2014; 1842: 594-602.
- [129] Ali KM, Wonnerth A, Huber K and Wojta J. Cardiovascular disease risk reduction by raising HDL cholesterol-current therapies and future opportunities. *Br J Pharmacol* 2012; 167: 1177-1194.
- [130] Oram JF and Lawn RM. ABCA1: the gatekeeper for eliminating excess tissue cholesterol. *J Lipid Res* 2001; 42: 1173-1179.
- [131] Wallace DC. Mitochondria and cancer. *Nat Rev Cancer* 2012; 12: 685-698.
- [132] Nishida N. Angiogenesis in cancer. *Vasc Health Risk Manag* 2006; 2: 213-219.
- [133] Tentori L, Lacal PM, Muzi A, Dorio AS, Leonetti C, Scarsella M, Ruffini F, Xu W, Min W and Stoppacciaro A. Poly(ADP-ribose) polymerase (PARP) inhibition or PARP-1 gene deletion reduces angiogenesis. *Eur J Cancer* 2007; 43: 2124-2133.
- [134] Tentori L, Muzi A, Dorio AS, Bultrini S, Mazzon E, Lacal PM, Shah GM, Zhang J, Navarra P and Nocentini G. Stable depletion of poly(ADP-ribose) polymerase-1 reduces in vivo melanoma growth and increases chemosensitivity. *Eur J Cancer* 2008; 44: 1302-1314.
- [135] Mao H, Lockyer P, Townley-Tilson WH, Xie L and Pi X. LRP1 regulates retinal angiogenesis by inhibiting PARP-1 activity and endothelial cell proliferation. *Arterioscler Thromb Vasc Biol* 2016; 36: 350-360.
- [136] Ferrara N. Role of vascular endothelial growth factor in the regulation of angiogenesis. *Kidney Int* 1999; 56: 794-814.
- [137] Ziche M, Maglione D, Ribatti D, Morbidelli L, Lago CT, Battisti M, Paoletti I, Barra A, Tucci M and Parise G. Placenta growth factor-1 is chemotactic, mitogenic, and angiogenic. *Lab Invest* 1997; 76: 517-531.
- [138] Elser M, Borsig L, Hassa PO, Erener S, Messner S, Valovka T, Keller S, Gassmann M and Hottiger MO. Poly(ADP-Ribose) Polymerase 1 Promotes Tumor Cell Survival by Coactivating Hypoxia-Inducible Factor-1-Dependent Gene Expression. *Mol Cancer Res* 2008; 6: 282-290.
- [139] Potente M, Ghaeni L, Baldessari D, Mostoslavsky R, Rossig L, Dequiedt F, Haendeler J, Mione M, Dejana E and Alt FW. SIRT1 controls endothelial angiogenic functions during vascular growth. *Genes Dev* 2007; 21: 2644-2658.
- [140] Guarani V, Deflorian G, Franco CA, Krüger M, Phng LK, Bentley K, Toussaint L, Dequiedt F, Mostoslavsky R and Schmidt MH. Acetylation-dependent regulation of endothelial Notch signalling by the SIRT1 deacetylase. *Nature* 2011; 473: 234-238.
- [141] Arany Z, Foo SY, Ma Y, Ruas JL, Bommi-Reddy A, Girnun G, Cooper M, Laznik D, Chinsomboon J and Rangwala SM. HIF-independent regulation of VEGF and angiogenesis by the transcriptional coactivator PGC-1 α . *Nature* 2008; 451: 1008-1012.
- [142] Phng LK and Gerhardt H. Angiogenesis: a team effort coordinated by notch. *Dev Cell* 2009; 16: 196-208.
- [143] Mulligan P, Yang F, Di Stefano L, Ji JY, Ouyang J, Nishikawa JL, Toiber D, Kulkarni M, Wang Q and Najafi-Shoushtari SH. A SIRT1-LSD1 corepressor complex regulates Notch target gene expression and development. *Mol Cell* 2011; 42: 689-699.

- [144] Di Paola R, Mazzon E, Xu W, Genovese T, Ferraris D, Muià C, Crisafulli C, Zhang J and Cuzzocrea S. Treatment with PARP-1 inhibitors, GPI 15427 or GPI 16539, ameliorates intestinal damage in rat models of colitis and shock. *Eur J Pharmacol* 2005; 527: 163-171.
- [145] Mota RA, Sánchez-Bueno F, Saenz L, Hernández-Espinosa D, Jimeno J, Tornel PL, Martínez-Torrano A, Ramírez P, Parrilla P and Yélamos J. Inhibition of poly(ADP-ribose) polymerase attenuates the severity of acute pancreatitis and associated lung injury. *Lab Invest* 2005; 85: 1250-1262.
- [146] Oliver FJ, Ménissier-de Murcia J, Nacci C, Decker P, Andriantsitohaina R, Muller S, de la Rubia G, Stoclet JC and de Murcia G. Resistance to endotoxic shock as a consequence of defective NF- κ B activation in poly (ADP-ribose) polymerase-1 deficient mice. *EMBO J* 1999; 18: 4446-4454.
- [147] Giansanti V, Donà F, Tillhon M and Scovassi AI. PARP inhibitors: new tools to protect from inflammation. *Biochem Pharmacol* 2010; 80: 1869-1877.
- [148] Popoff I, Jijon H, Monia B, Tavernini M, Ma M, McKay R and Madsen K. Antisense oligonucleotides to poly(ADP-ribose) polymerase-2 ameliorate colitis in interleukin-10-deficient mice. *J Pharmacol Exp Ther* 2002; 303: 1145-1154.
- [149] Jijon HB, Churchill T, Malfair D, Wessler A, Jewell LD, Parsons HG and Madsen KL. Inhibition of poly(ADP-ribose) polymerase attenuates inflammation in a model of chronic colitis. *Am J Physiol Gastrointest Liver Physiol* 2000; 279: G641-G651.
- [150] Kamboj A, Lu P, Cossoy MB, Stobart JL, Dolhun BA, Kauppinen TM, de Murcia G and Anderson CM. Poly(ADP-ribose) polymerase 2 contributes to neuroinflammation and neurological dysfunction in mouse experimental autoimmune encephalomyelitis. *J Neuroinflammation* 2013; 10: 49.
- [151] Scott GS, Kean RB, Mikheeva T, Fabis MJ, Mabley JG, Szabó C and Hooper DC. The therapeutic effects of PJ34 [N-(6-oxo-5, 6-dihydrophenanthridin-2-yl)-N, N-dimethylacetamide. HCl], a selective inhibitor of poly(ADP-ribose) polymerase, in experimental allergic encephalomyelitis are associated with immunomodulation. *J Pharmacol Exp Ther* 2004; 310: 1053-1061.
- [152] Chen F, Zhuang X, Lin L, Yu P, Wang Y, Shi Y, Hu G and Sun Y. New horizons in tumor microenvironment biology: challenges and opportunities. *BMC Med* 2015; 13: 45.
- [153] Baumeister SH, Freeman GJ, Dranoff G and Sharpe AH. Coinhibitory Pathways in Immunotherapy for Cancer. *Ann Rev Immunol* 2016; 34: 539-573.
- [154] Hareendran S, Ramakrishna B and Jayandharan GR. Synergistic inhibition of PARP-1 and NF- κ B signaling downregulates immune response against recombinant AAV2 vectors during hepatic gene therapy. *Eur J Immunol* 2016; 46: 154-166.
- [155] Rosado MM, Bennici E, Novelli F and Pioli C. Beyond DNA repair, the immunological role of PARP-1 and its siblings. *Immunology* 2013; 139: 428-437.
- [156] Saenz L, Lozano JJ, Valdor R, Baroja-Mazo A, Ramirez P, Parrilla P, Aparicio P, Sumoy L and Yélamos J. Transcriptional regulation by poly (ADP-ribose) polymerase-1 during T cell activation. *BMC Genomics* 2008; 9: 171.
- [157] Valdor R, Schreiber V, Saenz L, Martínez T, Muñoz-Suano A, Dominguez-Villar M, Ramírez P, Parrilla P, Aguado E and García-Cózar F. Regulation of NFAT by poly(ADP-ribose) polymerase activity in T cells. *Mol Immunol* 2008; 45: 1863-1871.
- [158] Luo X, Nie J, Wang S, Chen Z, Chen W, Li D, Hu H and Li B. Poly(ADP-ribosylation) of FOXP3 Protein Mediated by PARP-1 Protein Regulates the Function of Regulatory T Cells. *J Biol Chem* 2015; 290: 28675-28682.
- [159] Zhang P, Maruyama T, Konkel JE, Abbatiello B, Zamarron B, Wang ZQ and Chen W. PARP-1 controls immunosuppressive function of regulatory T cells by destabilizing Foxp3. *PLoS One* 2013; 8: e71590-e71590.
- [160] Chacon-Cabrera A, Femoselle C, Salmela I, Yelamos J and Barreiro E. MicroRNA expression and protein acetylation pattern in respiratory and limb muscles of Parp-1^{-/-} and Parp-2^{-/-} mice with lung cancer cachexia. *Biochim Biophys Acta* 2015; 1850: 2530-2543.
- [161] Adams JL, Smothers J, Srinivasan R and Hoos A. Big opportunities for small molecules in immuno-oncology. *Nat Rev Drug Discov* 2015; 14: 603-622.
- [162] Somnay YR, Lubner S, Kunnimalaiyaan M and Chen H. Velaparib (ABT-888), a Novel Inhibitor of Poly-Adp Ribosyl Polymerase (PARP), Synergizes With 5-Fluorouracil in Pancreatic Carcinoid Cells. *J Surg Res* 2013; 179: 311-311.
- [163] Donawho CK, Luo Y, Luo Y, Penning TD, Bauch JL, Bouska JJ, Bontcheva-Diaz VD, Cox BF, DeWeese TL and Dillehay LE. ABT-888, an orally active poly(ADP-ribose) polymerase inhibitor that potentiates DNA-damaging agents in pre-clinical tumor models. *Clin Cancer Res* 2007; 13: 2728-2737.
- [164] Muñoz-Gámez JA, Martín-Oliva D, Aguilar-Quezada R, Cañuelo A, Nunez MI, Valenzuela MT, de Almodovar JM, de Murcia G and Oliver FJ. PARP inhibition sensitizes p53-deficient breast cancer cells to doxorubicin-induced apoptosis. *Biochem J* 2005; 386: 119-125.

PARP-2 and cancer

- [165] Delaney CA, Wang LZ, Kyle S, White AW, Calvert AH, Curtin NJ, Durkacz BW, Hostomsky Z and Newell DR. Potentiation of temozolomide and topotecan growth inhibition and cytotoxicity by novel poly (adenosine diphosphoribose) polymerase inhibitors in a panel of human tumor cell lines. *Clin Cancer Res* 2000; 6: 2860-2867.
- [166] Tutt A, Robson M, Garber JE, Domchek SM, Audeh MW, Weitzel JN, Friedlander M, Arun B, Loman N and Schmutzler RK. Oral poly(ADP-ribose) polymerase inhibitor olaparib in patients with BRCA1 or BRCA2 mutations and advanced breast cancer: a proof-of-concept trial. *Lancet* 2010; 376: 235-244.
- [167] Mendes-Pereira AM, Martin SA, Brough R, McCarthy A, Taylor JR, Kim JS, Waldman T, Lord CJ and Ashworth A. Synthetic lethal targeting of PTEN mutant cells with PARP inhibitors. *EMBO Mol Med* 2009; 1: 315-322.
- [168] Ashworth A. A synthetic lethal therapeutic approach: poly (ADP) ribose polymerase inhibitors for the treatment of cancers deficient in DNA double-strand break repair. *J Clin Oncol* 2008; 26: 3785-3790.
- [169] Wahlberg E, Karlberg T, Kouznetsova E, Markova N, Macchiarulo A, Thorsell AG, Pol E, Frostell Å, Ekblad T and Öncü D. Family-wide chemical profiling and structural analysis of PARP and tankyrase inhibitors. *Nat Biotechnol* 2012; 30: 283-288.